

SILVERCREST®

COCOON 1105 TWIN

CORDLESS PHONE



USER GUIDE

V1.9 - 03/10



Handset

1. Display
2. Right hand display key (display functions)
3. Up key / Redial
4. Right key / Flash key
5. Hang up / Off key
6. Alphanumeric keys
7. Key lock # 
8. Dialling pause key P
9. Microphone
10. Ring tone off key * 
11. Ok key
12. Down key / Calls list
13. Answer call / On key / Hands free key
14. Left key / Internal call
15. Left hand display key (display functions)

Base station and charging station

16. Paging key
17. Handset call and charging display LED

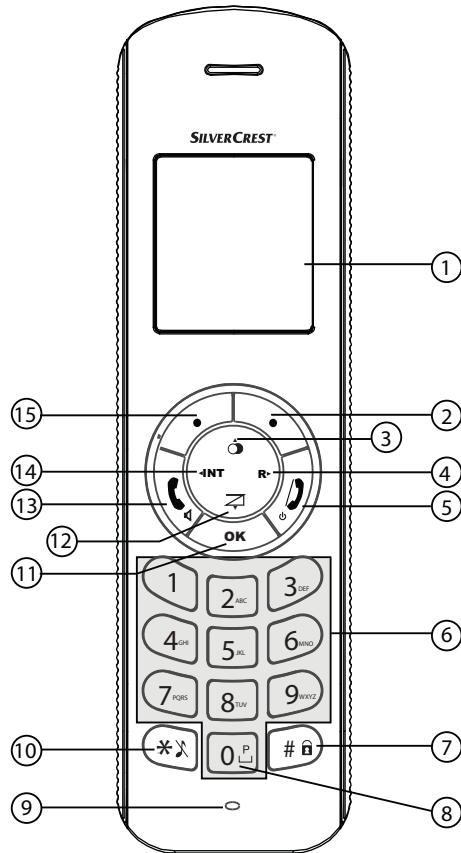

The CE symbol indicates that the unit complies with the essential requirements of the R&TTE directive.

The features described in this manual are published with reservation to modifications.



Caution

This product works with rechargeable batteries only. If you put non-rechargeable batteries in the handset and place it on the base, the handset will be damaged and this is NOT covered under the warranty conditions.

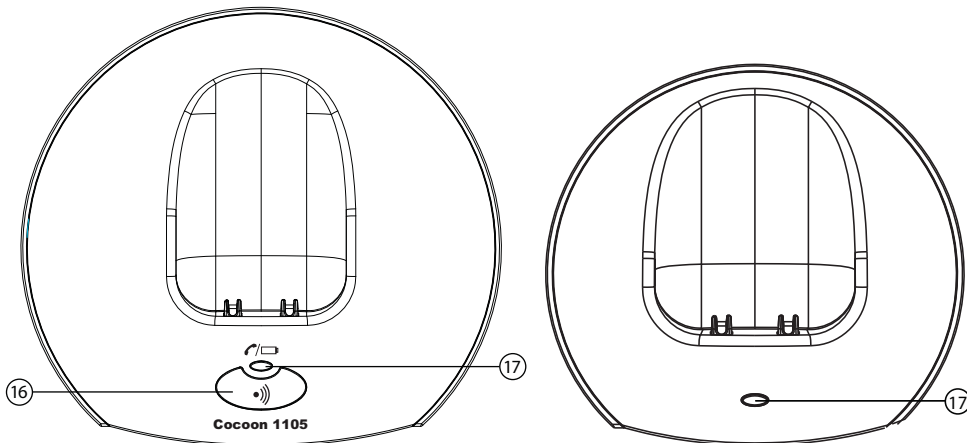

1	General information	5
1.1	The product: Cocoon 1105 / Cocoon 1105 Twin	5
1.2	Copyright	5
1.3	Signal words and symbols	5
1.4	Intended use	6
1.5	Contents of box	6
1.6	Safety notes	6
1.7	Notes on low-radiation operation	8
2	Installation	9
2.1	Commissioning the base station	9
2.2	Commissioning the charging station	10
2.3	Inserting rechargeable batteries into a cordless handset	10
3	Controls and menu structure	11
3.1	Keys / Displays / LEDs	11
3.2	Display (LCD)	12
3.3	Symbols	12
3.4	Display keys	13
3.5	LED display on the base station	13
3.6	Menu structure	13
3.7	Menu overview	14
4	Handset - Settings and operation	14
4.1	Switching the handset on/off	14
4.2	Menu language selection	14
4.3	Making calls	15
4.4	Answering a call	16
4.5	The calls list	16
4.6	Redial options	18
4.7	Activate / deactivate hands free mode	18
4.8	Setting the loudspeaker volume	18
4.9	Call duration display	18
4.10	Mute	19
4.11	Pause key (dialling pause)	19
4.12	Finding the handset from the base station (paging)	19
4.13	Using the alphanumeric keypad	19
4.14	Setting the ringer volume on the handset	19
4.15	Setting the ring tone on the handset	20
4.16	Setting the keypad lock	20
4.17	Switching the keypad beep on/off	20
4.18	Adjust display contrast	21
4.19	Changing the handset name	21
4.20	Auto Talk	21
4.21	Resetting the handset settings to "default" (Handset reset)	21
5	Time and alarm functions	22
5.1	Setting the date and time	22
5.2	Selecting the time format	22
5.3	The alarm function	23
5.4	Appointments	23
5.5	Stop Watch	23

6	Phone book	24
6.1	Save a new entry in the phone book.	24
6.2	Finding and calling a number in the phone book	24
6.3	Editing a phone book entry	24
6.4	Deleting one entry or all entries	25
6.5	Displaying the details of the phone book entries.	25
6.6	Copying a phone book entry to another handset	25
6.7	Copying all phone book entries to another handset	25
6.8	Adding all phone book entries to another handset	26
7	Base station operation	26
7.1	Setting the ring tone and ringer volume on the base station.	26
7.2	The Flash key (R)	27
7.3	Changing the PIN code (system PIN code)	27
7.4	Setting the dialling mode.	27
8	Additional handsets and base stations	28
8.1	Registering an additional handset.	28
8.2	De-registering a handset.	28
8.3	Selecting a base station	29
8.4	Using multiple handsets	30
8.5	Voicemail display	31
9	Abbreviations and technical terms	31
10	Troubleshooting	32
11	Servicing	33
11.1	Maintenance	33
11.2	Cleaning	33
11.3	Decommissioning, storage	33
11.4	Disposal (environmental protection)	34
12	Technical data	34
13	Warranty	35
13.1	Warranty period.	35
13.2	Warranty processing	35
13.3	Warranty exclusions	35
13.4	Service address and hotline	35
14	Index	36
15	Declaration of conformity and manufacturer	37

1 General information

This User Guide contains all the information you need to install, set up and operate your device. It also contains information and important notes for your safety and help in the event of problems.

1.1 The product: Cocoon 1105 / Cocoon 1105 Twin



Info

The product name "Twin" describes a variant consisting of a base station with cordless handset plus an additional charging station with an additional cordless handset (= Twin).

This product has been manufactured in accordance with the uniform digital standard for cordless telephones (DECT). DECT technology features a high level of security against interception as well as high-quality digital transmission. This telephone is intended for various applications, for example on a network of base stations and cordless handsets that make up a complete PBX: up to 5 cordless handsets can be operated on one base station and one cordless handset can be operated on up to 4 base stations. Internal calls can be made between any two cordless handsets.

If available on your line, caller ID and SMS services from your telephone service provider are possible on this telephone. If you use these services, the caller's telephone number is shown in the telephone display.



Important

To use "Caller ID", this feature must first be enabled for your telephone line. Contact your telephone service provider for information about activating this feature. If this feature is not enabled, the numbers from which incoming calls originate will NOT be shown in the telephone display.

1.2 Copyright

This document is protected by copyright.

All rights, including those of total or partial photomechanical reproduction, duplication and distribution by means of particular processes (such as data processing, data carriers and data networks), and substantive and technical changes, are reserved.

1.3 Signal words and symbols

Symbol	Signal word	Meaning
	Warning	Warning of risk of potential serious injury or death if you fail to comply with this information.
	Caution	Warning of risk of potential minor injury if you fail to comply with this information.
none	Caution	Risk of material or environmental damage.
	Important	This provides important information about the function.
	Info, tip	General information or particular tips.

1.4 Intended use

This product is intended for making telephone calls via a fixed line within a telephone network. The pre-requisite for proper use of the phone is professional installation taking account of the information in this User Guide.

Any other use is deemed improper and is not permitted.

Any modifications or conversions by the user that are not described in this User Guide, are deemed improper and are not permitted.

1.5 Contents of box

Check that the contents of the box are complete and undamaged. Contact your dealer immediately if parts are missing or defective.

Keep the packaging in case you need to return the telephone or send it for repair.

1 Base station

1 Mains adapter for Base station

1 Telephone cable for Base station

1 Charging station

2 Cordless handsets incl. 2 batteries (AAA, 1.2 V / 500 mAh, NiMH)
and one battery compartment cover for each handset

1 User Guide



Warning

Risk of suffocation for children! Keep packaging films out of the reach of children.



Important

Dispose of packaging material in an environmentally responsible way!

1.6 Safety notes

The following basic safety notes must always be taken into account when using electrical devices.

Carefully read the following safety notes and details on the correct use of the device.

Familiarise yourself with all the functions of the device. Keep this User Guide in a safe place near the device and pass it on to another user if necessary. Do not pass the telephone on to third parties without the User Guide.

Electrical risks:



Warning

Risk of injury or death due to electrical current!

In the event of danger, disconnect the device from the 230 V mains immediately.

- Do not use the device if the mains adapter, cable or device are damaged. Take care not to drop the device as it could be damaged.
- The voltage within the device is at hazardous levels. Never open the casing or insert object through the ventilation slot.
- Prevent liquids penetrating the device. If this should occur, unplug the mains adapter from the power socket and the telephone cable connector from the wall socket.
- Also unplug the mains adapter from the power socket and the telephone cable connector from the wall socket if faults occur during operation and before cleaning the device.

- Do not touch the charger and plug connectors with sharp or metal objects.
- Do not modify or repair the device. The device or cable should only be repaired by a specialist in the service centre. Repairs that are not carried out properly can cause significant risks to the user.
- Children frequently underestimate the dangers of handling electrical devices. Never allow children near electrical devices unsupervised.
- Do not use the device in humid areas (e.g. bathroom) or very dusty areas.
- Devices connected to the mains may be damaged during thunderstorms. Therefore always unplug the device in a thunderstorm.
- The mains adapter must be completely removed from the socket to disconnect the device fully from the power supply. Always pull the plug and never the cable.
- Check cables regularly for damage, protect them against hot surfaces and other hazards, unwind them fully, lay them so that nobody can trip over them and do not constrict them.

Fire risks:**Warning****Risk of injury or death due to fire!**

Do not expose the device to excessive heat and disconnect it from the 230 V mains supply immediately in the event of danger.

The heat generated inside the device may cause a fault or a fire in the device. Therefore do not expose this device to extreme temperatures:

- Avoid direct sunlight and heat
- Do not cover the ventilation slot on the device

Risk of explosion:**Warning****Risk of injury due to explosion!**

Exercise particular caution with batteries (disposable and rechargeable).

- Never throw disposable or rechargeable batteries into fire.
- Do not operate the device in an environment with a risk of explosions!

Risk of poisoning:**Warning****Risk of injury due to poisoning!**

Exercise particular caution in respect of children.

- Keep disposable and rechargeable batteries out of the reach of children.

Risk of suffocation:**Warning****Risk of injury due to suffocation!**

Exercise particular caution in respect of children.

- Keep packaging films out of the reach of children.
- Consider possible risks to children (strangulation) if you use extension cables.

Faults:**Warning****Possible risk of injury due to faults in the device!**

Exercise particular caution with medical electrical devices.

- The function of medical electrical devices may be affected by electromagnetic radiation from your device. Therefore make sure that the device is installed and operated sufficiently far away from medical electrical devices.
The same applies to implanted medical devices such as pacemakers.
- The cordless handset may cause an unpleasant buzz in hearing aids so keep it sufficiently far away from hearing aids.

Possible damage:**Caution****Possible damage to the device!**

Read the information in this User Guide.

- Only use the supplied main adapters. Do not use any third-party adapters as the rechargeable batteries could be damaged.
- The socket for connecting the mains adapter must be near the device and easily accessible.
- Only use the supplied rechargeable batteries. When they need to be replaced, use rechargeable batteries of the same type. Make sure the batteries are inserted the right way round (information can be found in the battery compartment on the device). Never use ordinary disposable batteries!

**Important**

As this device cannot be used in the event of a power failure, use a telephone that is not dependent on the mains power supply for any emergency calls e.g. a mobile phone.

1.7 Notes on low-radiation operation

This cordless telephone (compliant with the DECT standard) facilitates low-radiation operation (ECO mode).

During a call, the handset reduces the radio output depending on the distance from the base station. When no call is being conducted, the handset reduces the radio output to a minimum. The device also supports low-radiation operation because the base station reduces the radio output to practically zero if only one cordless handset is registered to the base station and it is sitting on the base station to charge. However, the base station does not reduce the radio output if two or more handsets are registered.

This does not mean that normal DECT radiation is harmful to health.

Rather, low-radiation operation avoids any unnecessary radiation exposure.

The base station does not reduce the radio output in the delivery configuration as a Twin set! Set up the base station in a location where you do not spend much time, for example in the hallway. Avoid setting it up in your or your children's bedrooms or the lounge.

2 Installation



Important Make sure the batteries are charged before using your telephone for the first time, otherwise the device will not operate optimally.



Caution Take account of the safety notes about the environment and circumstances of the installation and location! Do not commission the device in an environment with a risk of explosions!

2.1 Commissioning the base station

Perform the following steps:

- Plug the mains adapter into a 230 V socket. Plug the connector into the adapter jack on the bottom of the base station.
- Connect the telephone jack on the bottom of the base station to the telephone socket using the supplied telephone cable.

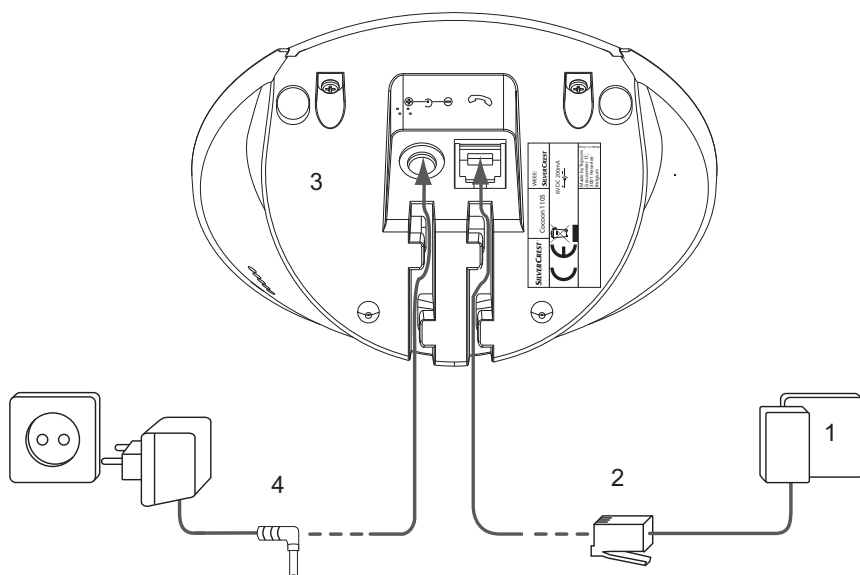

1. Telephone wall socket
2. Telephone cable
3. Bottom of the base station
4. Mains adapter cable

2.2 Commissioning the charging station

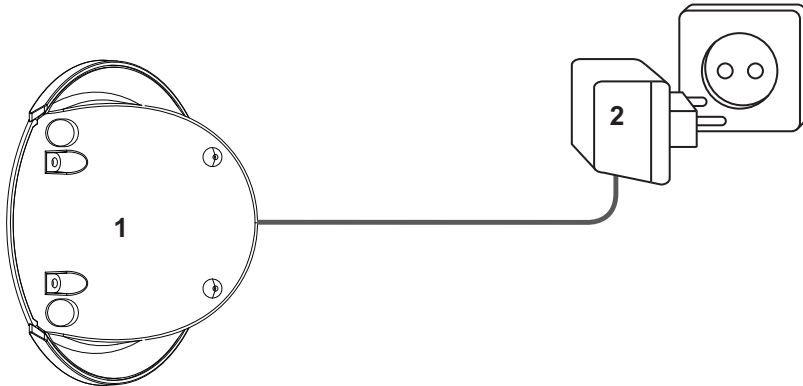

1. Bottom of the charging station
2. Mains adapter

2.3 Inserting rechargeable batteries into a cordless handset



Warning

Risk of injury due to explosion!

Only use the supplied rechargeable batteries or batteries of a similar type. Do not use ordinary disposable batteries!
Otherwise the cordless handset may be damaged.

1. Open the battery compartment (see below).
2. Insert the batteries **with the correct polarity (+ and -)**.
3. Close the battery compartment.
4. To charge the batteries for the first time, place the handset on the base station or charging station for 16 hours. The charging indicator  (LED) ⑰ on the base station or charging station lights up.

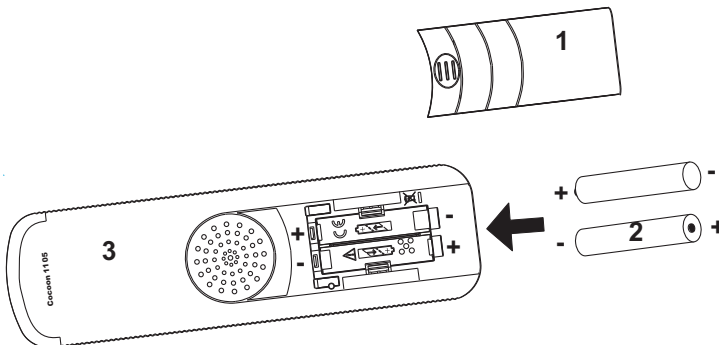

1. Battery compartment cover
2. Rechargeable batteries
3. Back of the handset

**Important**

Replace the handset in the base station or charging station after use to prevent the battery fully discharging. The batteries are designed for permanent charging.

3 Controls and menu structure

3.1 Keys / Displays / LEDs

Handset

1. Display
2. Right hand display key (display functions)
3. Up key / Redial
4. Right key / Flash key
5. Hang up / Off key
6. Alphanumeric keys
7. Key lock #
8. Dialling pause key P
9. Microphone
10. Ring tone off key *
11. Ok key
12. Down key / Calls list
13. Answer call / On key / Hands free key
14. Left key / Internal call
15. Left hand display key (display functions)

Base station and charging station

16. Paging key
17. Handset call and charging display LED

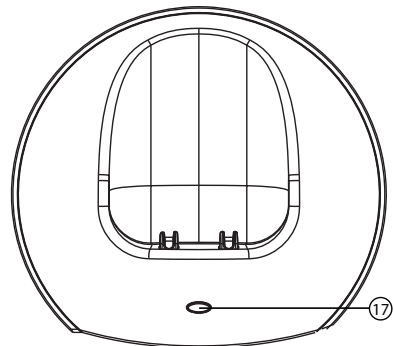
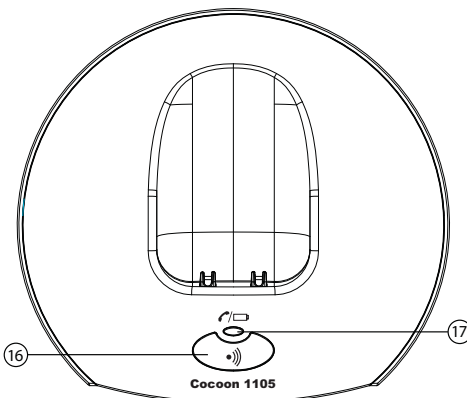
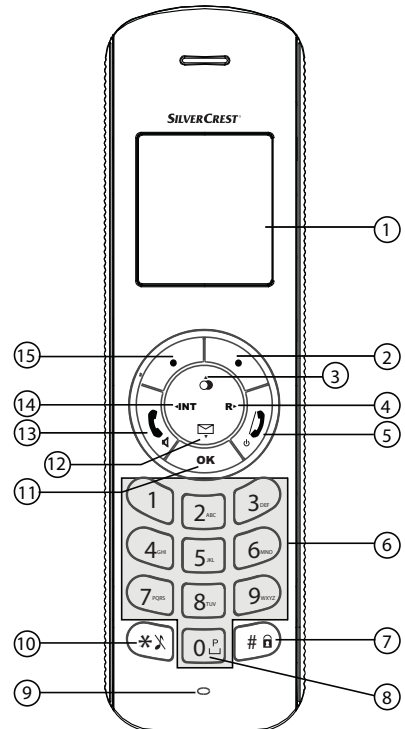

3.2 Display (LCD)

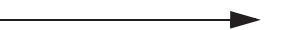
Symbol line 
 Text line 







Display menu / Option menu 













Info

The handset display has a protective film which must be removed during commissioning.

Battery display:

-  The batteries are fully charged.
-  The batteries are 75% full.
-  The batteries are half full (50%).
-  The batteries are only 25% full.
-  The batteries are almost flat. If the battery is almost flat, the battery symbol  in the display flashes and the message "Battery low!" appears.



3.3 Symbols

	On hook
	Call answered
	Ringing
	Internal call
	Hands free function enabled
	Keypad locked
ABC	Upper case letters
abc	Lower case letters
	Direction to other menu options
	Calls list entries*
	New mailbox message
	Handset ring tone off
	Alarm activated
Y	Aerial symbol: within range (permanent display) - out of range (flashing)

* If "caller ID" is activated for your telephone line.

3.4 Display keys

The display keys are the keys immediately below the display: ② and ⑮. Their function changes depending on the operating situation. The current function is shown directly above on the display. The main functions are:

 Phone book	 Mute
 OK / Confirm	 Back
 Menu	 Cancel
 Clear	

3.5 LED display on the base station



The LED  ⑰ displays the following:

- Off: the base station is not connected to the mains or the handset is not on the base station.
- On: handset charging in progress.
- Slow flashing: call answered or phone ringing.
- Fast flashing: during registration.

3.6 Menu structure

The handset has an easy-to-use menu structure. Every menu opens a list of options.

To open the main menu, press the left display key  ⑮ when the handset is on and in standby mode.

Press the  key ③ or the  key ⑫ to scroll through to the menu option you want. The instructions in this User Guide show the key symbols and the position number on the device overview. Then press  ② to open other options or to confirm the setting that is displayed.



Exit menu or go up a menu level

Press  ⑮ to go to the previous menu option.

You can press the  ⑤ key at any time to cancel and return to standby mode. If you do not press any key for 20 seconds, the handset automatically reverts to standby mode.

3.7 Menu overview

Menu	Sub-menu options
Phone book	
Handset	Ring tone Ringer volume Handset name Keypad Beep Contrast Auto Talk Select Base Language Registration
Base Settings	Ring tone Ringer volume Dial Mode Flash (Recall) PIN Number (System PIN)
Alarm (Time)	Set Alarm Date and Time Set Time Format
Tools	Appointment Stop Watch

4 Handset - Settings and operation



Info

The steps below show the key and display symbols and the position numbers on the device overview.



Caution

Possible danger due to faults in the device!

Follow the safety notes.

4.1 Switching the handset on/off

1. Press the On key (13) to switch the handset on.
2. To switch off the handset, hold down the Off key (5) until the device switches off.

4.2 Menu language selection





The telephone has various menu languages, see packaging for details.

To set the language, proceed as follows:







1. Press (15).
2. Press (3) or (12) repeatedly, select 'Handset'.
3. Press (2) to confirm.
4. Press (3) or (12) repeatedly, select 'Language'.
5. Press (2) to confirm.
 - The language setting appears in the display
6. Press (3) or (12) repeatedly, select the desired language.
 - Press (2) to confirm. The following appears in the display: 'Saved' Exit menu with saving: press (15).

4.3 Making calls



4.3.1 External calls

1. Press   (13).
 - The handset call and charging display  (LED) (17) on the base station flashes and the call symbol  appears in the display.
2. When you hear the dialling tone, dial the telephone number you want.
 - The number appears in the display and is dialled.
3. To end the call, press  (5) or replace the handset on the base station or charging station.







4.3.2 Call preparation

1. Enter the telephone number you want to call.
2. To correct the number, press  (15). Use the Left/Right key **INT** (14) or **R** (4) to move to the relevant position.
3. Press   (13).
 - The handset call and charging display  (LED) (17) on the base station flashes and the call symbol  appears in the display.
 - The telephone number is automatically dialled.
4. To end the call, press  (5) or replace the handset on the base station or charging station.

4.3.3 Redial the last number called.







1. Press  (3).
2. Press   (13).
 - The last number you called is automatically dialled.

4.3.4 Redial one of the last 10 numbers called.

1. Press  (3).
 - The last number you called appears in first position in the display.
2. Use  (3) or  (12) to select the telephone number you want.
3. Press the answer call key   (13).
 - The telephone number in the display is automatically dialled.
4. To end the call, press  (5) or replace the handset on the base station or charging station.





4.3.5 Calling a number in the phone book

The telephone has a phone book in which you can save telephone number with names (see also section "6 Phone book"). To dial a number from the phone book:

1. Press  (2).
 - The first number in the phone book appears in the display.
2. Press  (3) or  (12) repeatedly to select the number you want.
3. Press the answer call key   (13).
 - The telephone number in the display is automatically dialled.
4. To end the call, press  (5) or replace the handset on the base station or charging station.

4.4 Answering a call

The handset starts to ring during an incoming external or internal call. You can temporarily deactivate ringing by pressing **'Silent'** (15).



- All registered handsets ring when there is an incoming call.
 - The call symbol  flashes in the display.
 - The caller's number appears in the display if you have caller ID (CLIP). Contact your telephone line provider for more information. The caller's name is also shown in the display if:
 - the number is stored with the name in the phone book
 - the network transmits the name along with the phone number.
1. You have the following options for answering a call:
 - Press to   (13) to answer the call
 - Pick up the handset from the base station or charging station (function only possible if Auto Talk has been activated, see "4.20 Auto Talk").
 - During the call, the symbol , the transmitted caller number or name and the call duration are shown in the display.
 2. To end the call, press  (5) or replace the handset on the base station or charging station.

4.5 The calls list



When you receive a call, the caller's number, the date and time appear on the handset display. If the name is stored in the phone book, this is also shown. You need to have the "caller ID"(CLIP) feature activated by your telephone line provider for a call to be entered in the calls list.



Important The "caller ID" (CLIP) feature is only available if it is activated for your line. Contact your telephone line provider for additional information.

Incoming calls are stored in a calls list (max. 30 numbers). When the memory is full, new calls automatically overwrite the oldest number in the list. The upper symbol  flashes in the display when there are new unanswered calls in the calls list and the number of new calls is shown in the centre of the display next to the  symbol. If the calls list is empty and you press , **'Calls List Empty'** appears in the display.

4.5.1 Viewing entries in the calls list

1. Press  (12) briefly to view the newest entry.
 - The number of the latest caller is displayed in the top line. If the caller's name is entered in the phone book, this is shown in the first line. If there is no entry and the caller's number also was not transmitted, **'No Name'** is displayed.
 - The date and time at which each call was received are displayed in the second or third line.
 - The following information is also displayed in the third or fourth line:
 - **'New'**: Call that has not been viewed or was not answered
 - **'Old'**: Call that has been viewed or was answered
2. Press  (12) to view other entries in the list.

**Info**

If you do not press any of the (3) or (12) keys for 20 seconds, the telephone automatically reverts to standby mode.

After the end of a call, the caller's number is shown in the display for another 8 seconds after the last ring.

Caller ID does not work if a second call is received during a call.

4.5.2 Calling a number in the calls list

1. Press (12) to open the calls list.
2. Use (3) or (12) to select the telephone number you want.
3. Press (13) when the number appears in the display.
 - The telephone number is automatically dialled.

4.5.3 Saving a number from the calls list to the phone book

1. Press (12) to enter the calls list.
2. Use (3) or (12) to select the telephone number you want.
3. Press 'Option' (2).
4. Press (3) or (12) repeatedly, select 'Save Number'.
5. Press (2) to confirm.
 - 'Name' appears on the display.
6. Enter the name using the alphanumeric keys. If the name has been transmitted by the line provider, you can adopt this or modify it.
7. Press 'Save' (2).
 - The telephone number is displayed.
8. Amend the telephone number if necessary and press 'Save' (2) again to save the entry in the phone book.
9. Press (3) or (12) repeatedly to select the ring tone you want.
10. Press 'Save' (2).
 - The telephone reverts to the calls list.

4.5.4 Deleting numbers from the calls list**Deleting a call**

1. Press (12) to open the calls list.
2. Use (3) or (12) to select the telephone number you want.
3. Press 'Option' (2).
4. Press (3) or (12) repeatedly, select 'Delete'.
5. Press (2) to confirm.
 - The call is deleted and the next call appears in the display.

Deleting all calls





1. Press (12) to open the calls list.
2. Press 'Option' (2).
3. Press (3) or (12) repeatedly, select 'Delete All'.
4. Press (2) twice to confirm.
 - All calls will be deleted.









**Important**

Only old calls will be deleted. New calls that have not been viewed or were unanswered will be kept.

4.6 Redial options





When you scroll through the redial memory (see section "4.3.4 Redial one of the last 10 numbers called."), you have the following options:

If the number you want is shown in the display, press the **'Option'** key  and select from the following options with   or  .

- **'Save Number'** : saves the number in the phone book.
Press   to confirm. Enter a name (see also section "6.1 Save a new entry in the phone book." and press **'Save'**. .
Edit the number and press **'Save'** again .
Select the desired ring tone and press **'Save'** again .
- **'Delete'** : deletes an entry in the redial list.
Press   to confirm.
- **'Delete All'**: deletes all entries in the redial memory. Press   twice to confirm.





4.7 Activate / deactivate hands free mode

This function allows you to make a call without having to hold the handset in your hand.

1. Press   during a call to activate hands free mode.
2. Press   again to deactivate hands free mode.



Info



If you want to change the volume while in hands free mode, press   or   several times.







Important

The batteries discharge more quickly if you use hands free mode for a long time!

If the handset is out of range of the base station:

- **'Searching'** appears in the display and the  symbol flashes in the display.
 1. Move closer to the base station.
 2. The  symbol stops flashing and is displayed permanently.
- This means you are back within range of the base station.

4.8 Setting the loudspeaker volume

Press   or   during the call to adjust the loudspeaker volume. You can choose between 5 different settings. The default setting is Level '3':

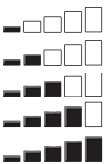

Volume 1

Volume 2

Volume 3

Volume 4

Volume 5



Info

The volume is adjusted in the same way in hands free mode.

4.9 Call duration display

The call duration is shown in the display during an external call:

A display of "01:10:40" means: 1 hour, 10 minutes and 40 seconds.

The call duration is shown in the display for another 2 seconds after the call is ended.

4.10 Mute

Press the display key  (15) to deactivate the microphone during a call. You can now speak freely without the party on the other end of the line being able to hear you. The display key 'Off' (15) must be pressed again to reactivate the the microphone.

4.11 Pause key (dialling pause)



If you want to insert a dialling pause while dialling a telephone number, press the Pause key P (8) at the appropriate point in the number until a P appears in the display.

If you then dial this number (or select it for redial), the dialling pause (approx. 3 seconds) is automatically dialled too.

4.12 Finding the handset from the base station (paging)

If you cannot find the handset, briefly press the paging key  (16) on the base station. All handsets registered on the base station ring which allows them to be located. Press any key on the handset to stop it ringing.

4.13 Using the alphanumeric keypad

Use the alphanumeric keypad to enter a text. Press the appropriate alphanumeric key to select a letter. For example, if you press the '5' numeric key, the letter 'J' appears in the display first. Press the key repeatedly to enter other characters assigned to this key. Press the '2' key once to select the letter 'A'. If you want to enter 'A' and 'B' in succession, first press the '2' key once to select the letter 'A'. Then wait until the display of all the letters on the key you have pressed (bottom left) is extinguished, then press key '2' twice to enter 'B'. You can use the delete key  (15) to delete letters that have been entered incorrectly. The character before the cursor is deleted. All characters in an entered sequence can be deleted at once by pressing and holding the delete key  (15) for 2 seconds. Use the Left/Right key, INT (14) or R (4) to move the cursor. Use the  (10) key to toggle between upper and lower case letters. The writing mode is shown at the top right of the display by the letters "abc" or "ABC".

If you want to change the script from English (ABC) to Latin (AÀÁ), Greek (ABΓ) or Russian (АБВ), press the # (7) key for 2 seconds each time.







Umlauts "Ä", "Ö" or "Ü" can be found in the Latin character set.





4.14 Setting the ringer volume on the handset

You can set the ringer volume for incoming calls (internal or external) to 6 levels (levels 1 to 5 and 'Off').

If you select 'Off', the  symbol appears in the display. The handset does not ring when there is an incoming call. Level "5" is the highest. (The default setting on the telephone is level "3".)

4.14.1 Setting the ringer volume for internal and external calls (0-5)



1. Press  (15).
 2. Press  (3) or  (12) repeatedly, select 'Handset'.
 3. Press  (2) to confirm.
 4. Press  (3) or  (12) repeatedly, select 'Ringer Volume'.
 5. Press  (2) to confirm.
- The current volume is displayed and can be heard.

6. Press  (3) or  (12) repeatedly to select the ringer volume you want.
7. Press 'Save'  (2) to confirm your selection or press  (15) to exit the menu without saving.



Info

Press the '**Silent**' display key to turn off the handset ringer during a call.

To turn off the handset ringer permanently, press and hold  (10) for approx. 3 seconds. The  symbol and '**Ringer Off**' appear in the display. To reactivate the ringer, press and hold  (10) again for 3 seconds.













4.15 Setting the ring tone on the handset

You can change the ring tone for an incoming call (internal or external). The device has 18 different ring tones to choose from (1-18).

The default ring tone setting for an external call is 10.

The default setting for an internal call is 1.



4.15.1 Setting the ring tone for internal and external calls (1-18)

1. Press the display key  (15).
 - Press  (3) or  (12) repeatedly, select '**Handset**'.
2. Press  (2) to confirm.
3. Press  (3) or  (12) repeatedly, select '**Ring Tone**'.
4. Press  (2) to confirm.
5. Select '**External**' or '**Internal**' and press  (2).
 - The current ring tone is displayed and can be heard.
6. Press  (3) or  (12) repeatedly to select the ring tone you want.
7. Press 'Save'  (2) to confirm your selection or press  (15) to exit the menu without saving.

4.16 Setting the keypad lock







You can lock the keypad to prevent accidental inputs. However, you can still answer incoming calls even when the keypad is locked.



Activating / deactivating the keypad lock:

1. Activate: press and hold the #  (7) key for approx. 3 seconds.
 - '**Keypad locked**' appears briefly and the keypad lock symbol  appears in the display.
2. Deactivate: Press the '**Unlock**' (15) key followed by #  (7) to unlock the keypad.
 - '**Keypad Unlocked**' appears briefly in the display.











4.17 Switching the keypad beep on/off

You can set the handset so that a beep is generated whenever you press a key.

1. Press  (15).
2. Press  (3) or  (12) repeatedly, select '**Handset**'.
3. Press  (2) to confirm.
4. Press  (3) or  (12) repeatedly, select '**Keypad Beep**'.
5. Press  (2) to confirm.









6. Select
 - 'On': switches the keypad beep on
 - 'Off': switches the keypad beep off
7. Press  (2) to confirm your selection or press  (15) to exit the menu without saving the setting.

4.18 Adjust display contrast

1. Press  (15).
2. Press  (3) or  (12) repeatedly, select 'Handset'.
3. Press  (2) to confirm.
4. Press  (3) or  (12) repeatedly, select 'Contrast'.
5. Press  (2) to confirm.
6. Select the contrast (8 contrast levels) using  (3) or  (12).
7. Press  (2) to confirm your selection or press  (15) to exit the menu without saving the setting.









4.19 Changing the handset name

Proceed as follows to change the handset name that is shown in the display in standby mode:

1. Press  (15).
2. Press  (3) or  (12) repeatedly, select 'Handset'.
3. Press  (2) to confirm.
4. Press  (3) or  (12) repeatedly, select 'Handset Name'.
5. Press  (2) to confirm.
6. Press  (15) repeatedly to delete the letters in succession and use the alphanumeric keypad to enter a new name.
7. Press 'Save' (2) to set the new handset name.

4.20 Auto Talk

When the handset is in the base station and receives an incoming call, the call is answered automatically when the handset is removed from the base station. You can choose whether or not this function should be activated.

1. Press  (15).
2. Press  (3) or  (12) repeatedly, select 'Handset'.
3. Press  (2) to confirm.
4. Press  (3) or  (12) repeatedly, select 'Autotalk'.
5. Press  (2) to confirm.
6. Select 'On' or 'Off' and press  (2) to confirm.

4.21 Resetting the handset settings to "default" (Handset reset)



You can reset all the handset settings to the factory settings and delete all entries from the phone book, calls list and redial memory.

The default settings are as follows:

Base Select	Auto select
Keypad Beep:	On
External Melody:	Melody 10
Internal Melody:	Melody 1

Ringer Volume:	Volume 3
Handset Volume:	Volume 3
Hands Free:	Volume 3
Contrast:	6
Time Format:	24 hour
Handset Name:	Handset
Phone Book:	Empty
Calls List:	Empty
Redial list:	Empty
Auto Talk:	Off

To reset the default settings:

1. Press and hold the Flash key **R** (4) for approx. 10 seconds until **'Handset Reset?'** appears.
2. Press  (2) to confirm your selection or press  (15) to cancel or exit the menu without resetting.







5 Time and alarm functions

5.1 Setting the date and time



Info

If caller ID (CLIP) is activated on your telephone line and the provider transmits the date and time, the clock is set automatically when an incoming call is received. The year is not set automatically.









1. Press  (15).
2. Press  (3) or  (12) repeatedly, select **'Time'**.
3. Press  (2) to confirm.
4. Press  (3) or  (12) repeatedly, select **'Date and Time'**.
5. Press  (2) to confirm.
6. Enter the last two digits of the year and press **'Save'** (2).
7. Enter the month as two digits and press **'Save'** (2).
8. Enter the date and press **'Save'** (2).
9. Enter the hours and press **'Save'** (2).
10. Enter the minutes and press **'Save'** (2).



Important

The date and time will be lost in the event of a base station power failure.

5.2 Selecting the time format

1. Press  (15).
2. Press  (3) or  (12) repeatedly, select **'Time'**.
3. Press  (2) to confirm.
4. Press  (3) or  (12) repeatedly, select **'Time Format'**.
5. Press  (2) to confirm.
6. Select the time format (12-hour or 24-hour clock) and press  (2).

5.3 The alarm function













Important Set the date and time before using this function so that the alarm sounds at the correct time.

You can set various alarms for handsets registered on the base station. The alarm only sounds on the handset and not on the base station or any other handset.



If an alarm is set, the alarm symbol  appears in the display in standby mode.

5.3.1 Setting an alarm

1. Press  (15).
2. Press  (3) or  (12) repeatedly, select '**Alarm / Clock**'.
3. Press  (2) to confirm.
4. Press  (3) or  (12) repeatedly, select '**Set Alarm**'.
5. Press  (2) to confirm.
6. Press  (3) or  (12) multiple times and select one of the 4 possible settings: '**Once**', '**OnDaily**', '**Mon to Fri**' or '**Off**'. Confirm by pressing  (2). If you select '**Once**', '**OnDaily**' or '**Mon to Fri**', the following appears in the display:

Time 24 hour:

07:00















7. Enter the alarm time as four digits and press '**Save**' (2) to confirm your input.
8. Press  (3) or  (12) repeatedly and select one of the 18 possible alarm melodies and press '**Save**' (2) to confirm.
9. To deactivate the alarm function, select '**Off**' and confirm with  (2).

5.3.2 Switching off the alarm



1. When the alarm sounds, you can switch it off by pressing '**Stop**' (15).
2. Press '**Snooze**' (2) for the alarm to sound again 5 minutes later.



5.4 Appointments

You can set five appointments/reminders to each of which you can assign a name and an alarm by date and time.

1. Press  (15).
2. Use  (3) or  (12) to scroll to '**Tools**' and press **OK** (11) or  (2).
3. The '**Appointment**' menu option is already highlighted. Press **OK** (11) or  (2).
4. Use  (3) or  (12) to scroll to one of the 5 appointments, press  (2).
5. Use  (3) or  (12) to select and then press  (2) to select the following options:
 - '**Edit**' to change the appointment settings. Edit the name of the appointment and press '**Save**'. (2) Enter the date of the appointment and press '**Save**'. (2) Enter the time and press '**Save**'. (2) Use  (3) or  (12) to select the desired ring tone (18 melodies) and press '**Save**'. (2).
 - '**Delete**' to delete the selected appointment. Press  (2) to confirm or  (15) to cancel.

5.5 Stop Watch



1. Press  (15).
2. Use  (3) to scroll to '**Tools**' and press **OK** (11) or  (2).

3. Use  (3) or  (12) to scroll to 'Stop Watch' and press **OK** (11) or  (2).
 4. Press '**Start**' (2), to start the stop watch and '**Stop**' (15), to stop it.
 5. Press '**Start**' again for the stop watch to resume (15).
- Press '**Reset**' to reset the stop watch to 00:00 (2).





6 Phone book

You can store 200 numbers (up to 24 digits long) with an associated name (up to 16 characters long) in the phone book.









6.1 Save a new entry in the phone book.

1. Press  (2).
2. To add a new entry, press '**Option**' (2) and confirm your selection of '**New Entry**' with  (2).
 - '**Name**' appears in the display. Enter the name using the alphanumeric keys.
3. Press '**Save**' (2) and enter the telephone number.
4. Press '**Save**' (2) and select the ring tone you want.
5. Press '**Save**' (2) to save the entry in the phone book or press  (15) to cancel without saving the entry.







6.2 Finding and calling a number in the phone book

1. Press  (2).
2. Enter the initial letters of the name using the alphanumeric keys.
 - The first name in the list with these letters appears in the display.
3. Press  (3) or  (12) repeatedly to scroll through the other numbers in the phone book.
4. Call the subscriber found: the desired number is highlighted. Press   (13).







6.3 Editing a phone book entry

1. Press  (2).
2. Enter the initial letters of the name.
 - The first name in the list with these letters appears in the display.
3. Press  (3) or  (12) repeatedly to scroll through the other numbers in the phone book.
4. Press '**Option**' when the number appears in the display (2).
5. Press  (3) or  (12) repeatedly and select '**Edit Entry**'.
6. Press  (2) to confirm.
7. Press  (15) to delete the individual letters and use the alphanumeric keypad to enter the correct name.
8. Press '**Save**' (2).
9. Press  (15) to delete each individual digit or hold down the  (15) key if you want to delete all the digits, then use the alphanumeric keys to enter the correct telephone number.
10. Press '**Save**' (2) and select the ring tone you want.
11. Press '**Save**' (2) to save the changes you have entered.

6.4 Deleting one entry or all entries

1. Press  (2).
2. Use the alphanumeric keypad to enter the initial letters of the name and/or use  (3) or  (12) to scroll to the desired entry.
3. Press 'Option' (2).
4. Select
 - 'Delete Entry?' to delete only the current entry.
 - 'Delete All' to delete all entries
5. Press OK key **OK** (11) or  (2).
6. Press  (2) again to confirm or  (15) to cancel without deleting.

6.5 Displaying the details of the phone book entries









1. Press  (2).
2. Use the alphanumeric keypad to enter the initial letters of the name and/or use  (3) or  (12) to scroll to the desired entry.
3. Press 'Option' (2).
4. Use  (3) or  (12) to scroll to 'Show Details' and press **OK** (11) or  (2).
 - The display shows the name, telephone number and ring tone that you have assigned to the entry.
5. Press  (15) to return to the list of entries.

6.6 Copying a phone book entry to another handset



Info

These functions are only possible if more than one handset is registered to the base station.



1. Press  (2).
2. Use the alphanumeric keypad to enter the initial letters of the name and/or use  (3) or  (12) to scroll to the desired entry.
3. Press 'Option' (2).
4. Use  (3) or  (12) to scroll to 'Copy Entry'.
5. Press **OK** (11) or  (2).
 - All available handsets (i.e. all handsets registered to the base station and available) are displayed.
6. Use **INT** (14) or **R** (4) to select the required handset and press **OK** (11) or  (2).
 - 'Copying to Handset x' appears in the display.
 - You will see 'Receive Phonebook Record?' in the display of the target handset.
7. Press  (2) on the target handset to confirm or  (15) to cancel transmission of the phone book entry.





6.7 Copying all phone book entries to another handset



Important







If you copy all entries from one handset to another, you will delete any existing entries on the target handset.

1. Press  (2).
2. Press 'Option' (2).
3. Use  (3) or  (12) to scroll to 'Copy All'.

4. Press **OK** (11) or  (2).
 - All available handsets (i.e. all handsets registered to the base station and available) are displayed.
5. Use **INT** (14) or **R** (4) to select the required handset and press the OK key **OK** (11) or  (2).
 - 'Copying to Handset x' appears in the display.
 - You will see 'Replace All Phonebook Record?' in the display of the target handset.
6. Press  (2) on the target handset to confirm or  (15) to cancel transmission of the phone book entries.

6.8 Adding all phone book entries to another handset











This function adds the phone book entries from one handset to the phone book on another handset without deleting the existing entries on the target handset.

1. Press  (2).
2. Press 'Option' (2).
3. Use  (3) or  (12) to scroll to 'Copy Append'.
4. Press **OK** (11) or  (2).
 - All available handsets (i.e. all handsets registered to the base station and available) are displayed.
5. Use **INT** (14) or **R** (4) to select the required handset and press the OK key **OK** (11) or  (2).
 - 'Copying to Handset x' appears in the display.
 - You will see 'Receive Phonebook Record?' in the display of the target handset.
6. Press  (2) on the target handset to confirm or  (15) to cancel transmission of the phone book entries.







7 Base station operation

7.1 Setting the ring tone and ringer volume on the base station

7.1.1 Setting the base station melody

1. Press  (15).
2. Press  (3) or  (12) repeatedly, select 'Base Settings'.
3. Press  (2) to confirm.
 - Press  (3) or  (12) repeatedly, select 'Ring Tone'.
4. Press  (2) to confirm.
 - The current ring tone is displayed and is sounded.
5. Press  (3) or  (12) repeatedly, select the desired melody (1-9).
6. Press 'Save' (2) to confirm your selection or press  (15) to exit the menu without saving.

7.1.2 Setting the base station ringer volume

1. Press  (15).
2. Press  (3) or  (12) repeatedly, select 'Base Settings'.
 - Press  (2) to confirm.
3. Press  (3) or  (12) repeatedly, select 'Ringer Volume'.
4. Press  (2) to confirm.

- The current volume is displayed and can be heard.
- 5. Press (3) or (12) repeatedly to select the volume (0-5).
- 6. Press 'Save' (2) to confirm your selection or press (15) to exit the menu.

7.2 The Flash key (R)

You can use the Flash key **R** (4) to use or activate certain services on your external calls, such as

'call waiting' (providing your telephone line provider offers this feature). the Flash key is also used for internal recall or for connecting a call when operating the telephone on a PABX. The Flash key **R** causes a brief interruption in the line. You can set this interruption time to 100 ms or 300 ms.

1. Press (15).
2. Press (3) or (12) repeatedly, select 'Base Settings'.
3. Press (2) to confirm.
 - Press (3) or (12) repeatedly, select 'Recall'.
4. Press (2) to confirm.
5. Press (3) or (12) multiple times to select the flash time you want.
 - 'Long' = 300 ms
 - 'Short' = 100 ms
6. Press 'Save' (2) to confirm or press (15) to exit the menu.

7.3 Changing the PIN code (system PIN code)

Some functions are only available if you know the PIN code for the base station. The PIN code comprises 4 digits and the default code is '0000'. Proceed as follows to change the preset PIN code or to enter a new PIN code:

1. Press (15).
2. Press (3) or (12) repeatedly, select 'Base Settings'.
3. Press (2) to confirm.
 - Press (3) or (12) repeatedly, select 'System PIN'.
4. Press (2) and enter the old PIN code.
5. Press (2). If an incorrect PIN code is entered, 'Incorrect PIN' appears in the display. If you have entered the correct PIN code, you are prompted to enter a new PIN code. Enter the new system PIN and press (2).
6. Enter the new system PIN again and press (2).









7.4 Setting the dialling mode

There are two different dialling modes that can be used when making calls:

- DTMF = dual tone multiple frequency, or tone dialling (today's modern dialling mode)
- Pulse dialling (in older devices)

Modern devices are equipped with both functions which can be changed depending on the application. DTMF is required for programming or control functions, for example, if the device is operated on a PBX. If pulse dialling is used, malfunctions can occur on PBXs during normal operation because the system interprets the pulse dialling signals incorrectly.

Changing the dialling mode:

1. Press  (15).
2. Press  (3) or  (12) repeatedly, select 'Base Settings'.
3. Press  (2) to confirm.
4. Press  (3) or  (12) repeatedly, select 'Dial Mode'.
5. Press  (2) to confirm.
6. Select the desired dialling mode with  (3) /  (12) and press 'Save' (2) to confirm.

8 Additional handsets and base stations



Up to 5 handsets can be registered to one base station. Each handset can in turn be registered to up to 4 base stations and the user can select which base station he wants to use. In the default factory settings, each handset is registered to the base unit as handset 1.

8.1 Registering an additional handset















Info

This is only necessary if you have de-registered a handset or bought a new one.

Hold down the paging key  (16) on the base station for 10 seconds until the call/handset display  (17) on the base station begins to flash quickly.

Registration mode on the base station is now activated for approx. 3 minutes. You must perform the following steps to register a handset:

1. Press  (15).
 2. Press  (3) or  (12) repeatedly, select 'Handset'.
 3. Press  (2) to confirm.
 4. Press  (3) or  (12) repeatedly, select 'Registration'.
 5. Press  (2) to confirm.
 6. Select 'Register' and press  (2).
 7. Select the desired base station (1-4) with  (3) /  (12) and press  (2).
 8. Enter the base station PIN code (system PIN, default 0000) and press  (2).
- The handset will now search for the base station and register when it has found it. Following successful registration, the display shows standby mode and the handset name and number.



Info

You can register each handset to up to 4 different DECT base stations. The base stations are numbered 1 to 4 within a handset. When you register a new handset, you can assign it to a base station.









8.2 De-registering a handset

It is possible to de-register a handset from a base station. You should do this, for example, if a handset is damaged and needs to be replaced.



Important

You can only de-register a different handset i.e. not the one you are using to perform the de-registration.









1. Press  (15).
2. Press  (3) or  (12) repeatedly, select 'Handset'.
3. Press  (2) to confirm.
4. Press  (3) or  (12) repeatedly, select 'Registration'.
5. Press  (2) to confirm.
6. Select 'De-register' and press  (2).
7. Enter the system PIN (base station PIN code) and press  (2).
8. Select the handset to be de-registered by pressing the keypad (1-5).
9. Press **OK** (11) or the right hand display key to de-register.

8.3 Selecting a base station

If your handset is registered to more than one base station (max. 4), you must select one of these base stations since the handset only communicates with one base station at a time. There are two options:

8.3.1 Auto Select

If you set the handset to 'Auto Select', the handset will automatically search for the nearest base station in standby mode.

1. Press  (15).
2. Press  (3) or  (12) repeatedly, select 'Handset'.
3. Press  (2) to confirm.
 - Press  (3) or  (12) repeatedly, select 'Select Base'.
4. Press  (2) to confirm.
5. Select 'Auto' and press  (2) to confirm.













Info

If you allow the base station to be selected automatically and the handset goes out of range of the current base station, the handset will only search for the strongest base station in standby mode (not during a call).

8.3.2 Manual Select

If you set the handset to 'Manual Select', the handset will only search for the base station you have set.

1. Press  (15).
2. Press  (3) or  (12) repeatedly, select 'Handset'.
3. Press  (2) to confirm.
4. Press  (3) or  (12) repeatedly, select 'Select Base'.
5. Press  (2) to confirm.
6. Select 'Manual' and press  (2) to confirm.
7. Use  (3) or  (12) to select the base station and press  (2) to confirm.



Important

For the base and the handset to be able to communicate, the handset must be registered to that base.

8.4 Using multiple handsets





Info

These functions are only possible if more than one handset is registered to the base station.



8.4.1 Call another handset

1. Press **INT** (14).
 - 'Internal _' appears in the display.
2. Dial the phone number of the handset you want to call.
3. Press  (5) to hang up at the end of your call.

8.4.2 Answering an internal call



- The internal call symbol  and the phone number of the calling handset appear in the display.
1. Press  (13) to answer the internal call.

OR

1. Lift the handset off its base station (if Auto Talk is selected, see section "4.20 Auto Talk").
 - The handset number of the calling handset and the symbol  appear in the display during the call.
2. Press  (5) to hang up at the end of your call.

8.4.3 Answering an external call during an internal call

If you receive an external call during an internal call, you will hear the call waiting tone (double beep) in both handsets involved in the internal call.

1. Press  (5).
 - The internal call is ended.
2. Press  (13).
 - You have now answered the external call.

8.4.4 Forwarding a call to another handset

- You have an external caller on the line.
1. Press **INT** (14).
 - 'Internal _' appears in the display.
 2. Dial the phone number of the handset to which you want to connect the caller.

EITHER

- the called handset answers and you can conduct an internal call.
3. Press  (5) to connect the external caller to the called handset.

OR

- The internal called party does not answer.
4. Press 'End' (2) to talk to the external caller again.

8.4.5 Conference calls (two internal handsets and an external caller)

You can conduct a phone call with an internal and an external party at the same time.

1. Press **INT** (14) while you are talking to the external caller.
 - The external line is put on hold.
2. Dial the phone number of the handset you want to involve in the call. You can toggle between the internal and external line by pressing **INT** (14) .

3. If the dialled handset answers, press '**Conf.**' ②.
- You are now connected to an external and an internal party and can talk to both of them at the same time (conference call).

8.5 Voicemail display

This display only works if you have enabled the voicemail or telephone message service and your line provider transmits this information along with the caller ID!

When you receive a new message in your voicemail box, the ☒ symbol appears in the display. The ☒ symbol disappears when you have listened to your message.

9 Abbreviations and technical terms

CLIP

Calling Line Identification Presentation, display of the caller's telephone number on the called party's display.

DECT

Digital Enhanced Cordless Telecommunication; European telecommunications standard for digital cordless telephones.

ECO mode

Economic Mode; in DECT telephony this is low-radiation operation.

Flash key

Effects a brief line interruption that is used to activate features such as toggling or call forwarding. On PBXs, the flash or R key is used for internal recall.

GAP

Generic Access Profile; interface between the base station and handset that facilitates the cordless connection.

GFSK

Gaussian Frequency Shift Keying; digital modulation method to reduce crosstalk problems in telephony.

INT

Internal subscriber. Other handset or extensions within a PBX

Pulse mode

Obsolete analogue dialling mode ("clattering" dialling noises).

LCD

Liquid Crystal Display

LED

Light Emitting Diode

DTMF

Dual Tone Multiple Frequency; modern, digital dialling mode.

Paging

Base station search function. When the paging key (16) is pressed, all registered handsets ring.

PIN

Personal Identification Number.

R key

Recall key (see Flash key).

Stand by

"Idle" status of a device without being completely switched off.

Twin

Designation for a device unit with two identical devices e.g. two handsets.

Dialling pause

You may need a dialling pause when operating your telephone on a PBX, for example, if the latter does not correctly identify the number dialled to access an external line (e.g. the "0"). In this case you can insert a pause after the number to access an external line is dialled.

10 Troubleshooting



Warning

Risk of injury or death due to electrical current!

In the event of danger, disconnect the device from the 230 V mains immediately.

Symptom	Possible cause	Solution
Display remains dark.	Batteries inserted incorrectly.	Check the position of the batteries (see "2 Installation").
	Batteries not charged.	Charge the batteries.
	Handset is switched off.	Switch on the handset.
	No power.	Check that the devices has the correct power supply.
No sound.	Telephone cable incorrectly connected or defective.	Check the connection of the telephone cable (see "2 Installation").
	The line is engaged by a different handset.	Wait until the other handset hangs up.
The Y symbol is flashing.	Handset is out of range.	Move closer to the base station with the handset.
	The base station has no power.	Check the power connection to the base station.
	The handset is not registered to the base station.	Register the handset to the base station (see "8.1 Registering an additional handset").
The base station or handset does not ring.	The ringer volume is off or too low.	Set the ringer volume (see "4.14 Setting the ringer volume on the handset" and "7.1 Setting the ring tone and ringer volume on the base station").
No connection despite good sound quality.	The dialling mode is incorrect.	Check the dialling mode (see "7.4 Setting the dialling mode").

Calls cannot be forwarded on a PBX.	The flash time is too short.	Set the device to a long flash time (see "7.2 The Flash key (R)").
Telephone does not respond when keys are pressed.	Programming error.	Remove the batteries and then insert them again after 1 minute.
"Incorrect PIN" error message in the display.	An incorrect PIN has been entered or the handset cannot be registered because the maximum number of handsets have already been registered.	Check PINs and handsets.

Do not modify or repair the device. The device or cable should only be repaired by a specialist in the service centre. Repairs that are not carried out properly can cause significant risks to the user.

11 Servicing

11.1 Maintenance

The device is maintenance-free. Occasionally check the condition of the batteries and replace them with new batteries of the same type if performance is impaired or if they are beginning to leak.



Warning **Danger of chemical burns!**

Wear protective gloves to remove flat rechargeable batteries.

if the device comes into contact with liquid, remove the batteries immediately and disconnect the device from the power supply (base station) and dry it out carefully. Check its operation after 2-3 days. Send it into the service centre if it is defective.

11.2 Cleaning



Warning

Risk of electric shock or short circuit from contact with components that conduct electricity.

Prevent liquids penetrating the device. If this should occur, unplug the mains adapter from the power socket and the telephone cable connector from the wall socket and remove the batteries.

Do the same if the device, cable or mains adapter are damaged: avoid direct contact with liquids and disconnect the device from the 230 V mains immediately.

Clean the telephone with a damp cloth that has been dipped in lukewarm water or an anti-static cloth. Never use cleaning agents or abrasives.

11.3 Decommissioning, storage

To decommission the device temporarily, disconnect the telephone cable from the wall socket and from the telephone jack on the base station. Unplug the base station and handset mains adapters from the 230 V sockets.

Remove the batteries from the handsets. If the telephone is decommissioned for a long time, replace the rechargeable batteries with new ones of the same type when the phone is recommissioned.

Store the devices and rechargeable batteries in a dry place that is not too warm.

11.4 Disposal (environmental protection)



The device and rechargeable batteries must not be disposed of in normal household refuse at the end of their service life. This is indicated by this symbol on the product and/or on the packaging. Take the device to a collection point for recycling electrical and electronic devices. Some of the materials in the product can be recycled there. You can help the environment by recycling some parts or

raw materials from used products.

Also dispose of packaging materials in an environmentally friendly way.

Contact your local authority for more information on collection points in your area.

12 Technical data

Telephony standards:	DECT / GAP
Frequency range:	1880 MHz to 1900 MHz:
Number of channels:	120 duplex channels
Modulation:	GFSK
Encoding speed:	32 kbit/s
Emissions:	10 mW (average output per channel)
Range:	300 m in open terrain Max. 50 m in buildings
Power supply base station:	Input: 230 V~/50 Hz Output: 6 V~/200 mA
Power supply charging station:	Input: 230 V~/50 Hz Output: 7.5 V~/100 mA
Handset, batteries:	2 AAA (NiMH) rechargeable batteries, 1,2 V/500 mAh
Handset, battery life:	100 hours in standby mode
Talk time:	10 hours
Charging time:	16 hours
Dialling mode:	DTMF (dual tone multiple frequency) Pulse dialling
Flash time:	100 ms or 300 ms
Temperature (operation):	+5 °C to +45 °C
Temperature (storage):	0 °C to 60 °C
Relative humidity (operation):	Max. 70 % (non-condensing)
Dimensions:	Handset: 160 mm x 44 mm x 22 mm
(height x width x depth)	Base station: 89 mm x 127 mm x 85 mm Charging station: 65 mm x 94 mm x 73 mm
Weight:	Handset incl. 2 batteries: 104.8 g Base station incl. mains adapter 250.3 g Charging station incl. mains adapter 159 g
Maximum power consumption:	Base station and handset: 1.7 W Charging station and handset: 1.7 W

13 Warranty

13.1 Warranty period

These devices have a 36-month warranty. The guarantee period begins on the day on which the new device was purchased. The warranty does not cover ordinary disposable or rechargeable batteries (AA and AAA).

The warranty excludes wear and tear or defects that have only a minor effect on the value or function.

Warranty claims must be accompanied by the original receipt or a copy thereof, showing the purchase date and device model.

13.2 Warranty processing

Send the defective device to an authorised service centre, in its original packaging if possible, together with a valid receipt.

If the device develops a fault during the warranty period, the authorised service centre will resolve any defect caused by a material or manufacturing fault by repairing or replacing the device or the relevant parts. If the device is replaced, the colour and model may vary from the device originally purchased. The start of the warranty period is determined by the original date of purchase. The warranty period will not be extended if the device is repaired or replaced by an authorised service centre.

13.3 Warranty exclusions

Damage or defects caused by incorrect use or operation, and defects caused by the use of non-original parts or accessories, are not covered by the warranty.

The warranty does not cover any damage caused by external influences such as lightning, water, fire or any transport damage.

The warranty shall be invalidated if the serial number of the device is changed, removed or rendered illegible. All warranty claims shall become null and void if the purchaser has repaired, modified or converted the device.

This device may only be operated with rechargeable batteries. If you want to replace the original rechargeable batteries supplied, check that the new batteries are suitable and rechargeable. Under NO circumstances may ordinary disposable batteries be used in the handsets. If you use disposable batteries and place the handset in the base station, the batteries will heat up and may explode. Any defects caused by the use of disposable batteries will not be compensated by the manufacturer and any device damaged in this way will not be covered by the warranty. All repairs will be billed to you.

13.4 Service address and hotline

See the enclosed leaflet (service address and support numbers) or go to www.ucom.be.

14 Index

A		K	
Abbreviations	31	Keypad	19
Adding a handset	28	Keypad lock	20
Alarm	23	L	
Alarm function	23	Light Emitting Diodes	13
Answering a call	16	M	
Appointments	23	Making calls	15
Auto Talk	21	Menu language	14
B		Menu overview	14
Base station	26	Menu structure	11
C		Multiple handsets	30
Calls list	16	Mute	19
Commissioning	9, 10	O	
Conference calling	30	Operating the handset	14
Contents of box	6	P	
Controls	11	Paging	19
D		Phone book	24
Date	22	PIN code	27
Default settings	22	Pulse mode	27
De-registering a handset	28	R	
Dialling mode	27	R key	27
Dialling pause	19	Rechargeable batteries	10
Display	12	Redial	18
Display contrast	21	Reset	21
DTMF	27	Ring tone	20, 26
E		Ringer volume	19
ECO mode	8	Ringer volume (base station)	26
External calls	15	S	
F		Safety notes	6
Finding the handset	19	Selecting a base station	29
Flash key	27	Signal words	5
Forwarding	30	Speaker volume	18
G		Stop Watch	23
General information	5	Symbols	5
H		T	
Hands free mode	18	Time	22
Handset name	21	Time format	22
I		V	
Installation	9	Voicemail display	31
Intended use	6		

15 Declaration of conformity and manufacturer

Topcom Europe Nv.

Grauwmeer 17 - 3001 Heverlee - Belgium

DECLARATION OF CONFORMITY

We manufacturer, Topcom Europe Nv, Grauwmeer 17, 3001 Heverlee, Belgium, declare that our product :

Type: Wireless Telephone Device (DECT)

Model: Cocoon 1105 & Cocoon 1105 Twin

Class of equipment: Class 1

is in compliance with the essential requirements and other relevant provisions of the R&TTE directive 1999/5/EC and carries the CE mark accordingly.

Supplementary information:

The product complies with the requirements of:

Directive 1999/5/EC (R&TTE)

Safety:

CENELEC EN 60950-1/all:2009

EMC:

ETSI EN 301 489-1 V1.8.1

ETSI EN 301 489-6 V1.3.1

Efficient use of frequency spectrum:

ETSI EN 301 406 V1.5.1

Health:

CENELEC EN 50360:2001-07

CENELEC EN 50385:2002-08

Directive 2009/125/EC (EuP)

Regulation 278/2009

Date: 10/3/2010

Place: Heverlee, Belgium

Name: Verheyden Geert

Function: Technical Director

Signature:

European contact: Topcom Europe Nv, R&D department, Research Park, Grauwmeer 17, 3001 Heverlee, Belgium. Tel : +32 16 398920, Fax : +32 16 398939

Cocoon 1105 Twin

**visit our website
www.ucom.be**