

# **SILVERCREST®**

## **COMFORT TELEPHONE WITH HANDSET**

### **COCOON 8410**



### **USER GUIDE**

V 1.8 - 3/11



## **Before Initial use**

Thank you for purchasing this new digital cordless telephone.

### **Intended Purpose:**

This product is intended to be connected indoors to an analogue telephone line.

This product is made in accordance with the Digital Enhanced Cordless Telecommunications (DECT). DECT technology is characterized by high-security protection against interceptions as well as high-quality digital transmission. This telephone was designed for a wide range of applications. For example, this telephone can be used within a network of 5 handsets.

Caller ID is a network provider service. After subscribing to Caller ID, this phone will display the caller's phone number.

### **Important**

To use 'Caller ID' (display caller), this service has to be activated on your phone line. Normally you need a separate subscription from your telephone company to activate this function. If you don't have the Caller ID function on your phone line, the incoming telephone numbers will NOT be shown on the display of your telephone.

## Cordless handset

1. Redial / Up
2. Phone book
3. Mute / Delete
4. Hang up
5. Alphanumeric keys
6. Key lock
7. Pause
8. Ringer ON/OFF
9. Calls list / Down
10. Answer call / Hands free / Call button
11. INT / Escape
12. Menu / OK / Flash
13. Display
14. Red LED, flashes during a call

## Base station

15. Escape
16. Menu / OK
17. Left
18. Redial / Up
19. Right
20. Display
21. Phone book
22. Calls list / Flash
23. Down
24. Abbreviated dialling (M1 - M2 - M3)
25. Hands free
26. Alphanumeric keys
27. Red LED on the base station, flashes during a call
28. Paging / Call diversion / Internal call

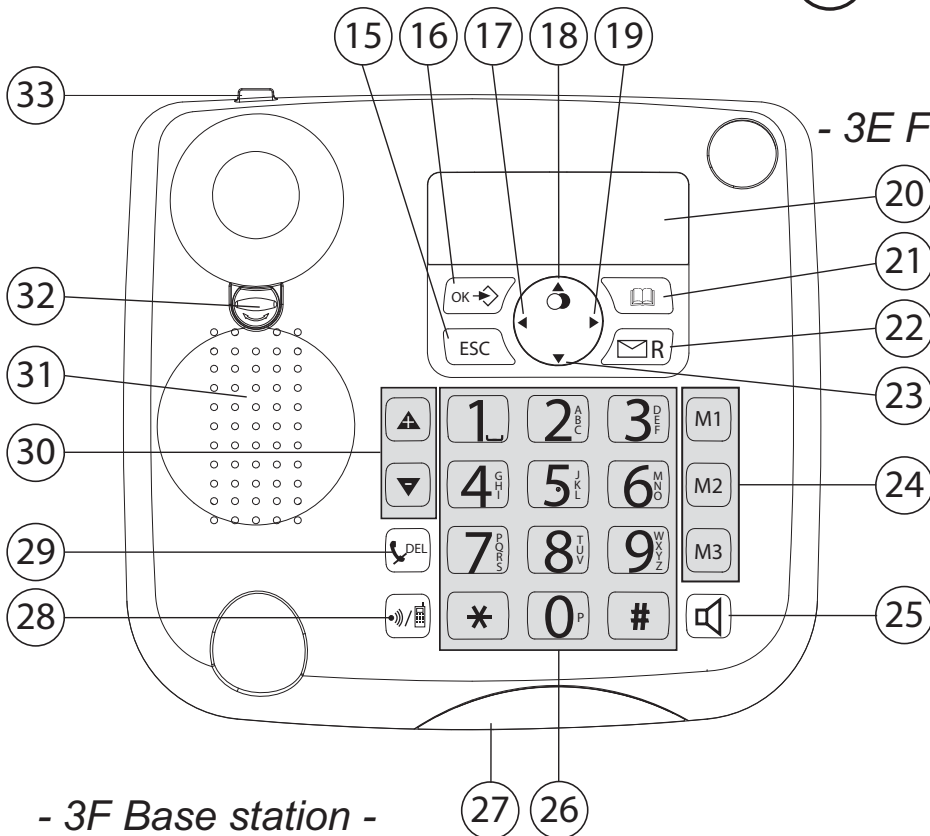

- 3F Base station -

29. Mute / Delete
30. Volume control
31. Loudspeaker
32. Receiver holder for wall mounting
33. Lug: for putting down the receiver briefly during a call when the phone is wall-mounted

## Charger

34. LED: Handset charging in progress.

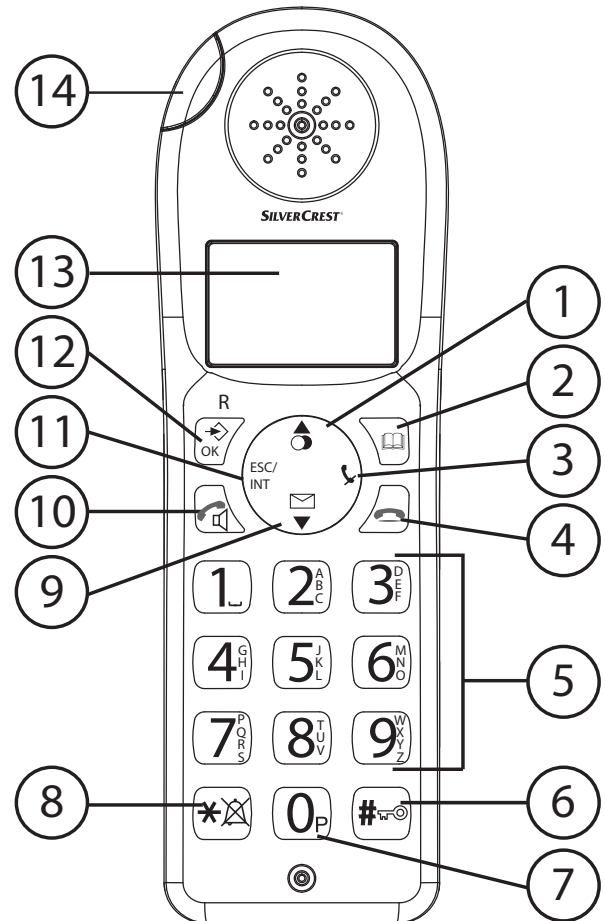

- 3E Front of the handset -

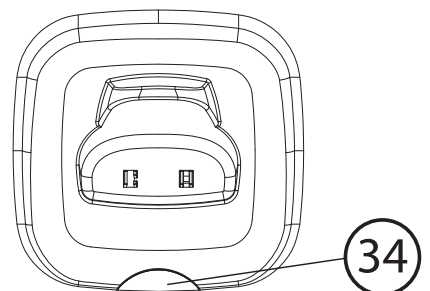

- 3G Charger -

**Caution**

This product works with rechargeable batteries only. If you put nonrechargeable batteries in the handset and place it on the base, the handset will be damaged and this is NOT covered under the warranty conditions.

To be connected to the public analogue telephone network.

The features described in this manual are published with reservation to modifications.

The CE symbol indicates that the unit complies with the essential requirements of the R&TTE directive.

<b>1</b>	<b>General information</b>	<b>5</b>
1.1	The product: Cocoon 8410	5
1.2	Copyright	5
1.3	Signal words and symbols	6
1.4	Intended use	6
1.5	Contents of box	6
<b>2</b>	<b>Safety notes</b>	<b>7</b>
2.1	Notes on low-radiation operation	10
<b>3</b>	<b>First steps</b>	<b>10</b>
3.1	How to use this User Guide	10
3.2	Installing the base station	10
3.3	Handset charger	11
3.4	Handset	12
3.5	Wall mounting	12
3.6	Battery status display	13
3.7	Keys/Display	13
3.8	Handset display	15
3.9	Base station display	15
3.10	Navigating through the menu	16
3.11	Using the alphanumeric keys	17
<b>4</b>	<b>Operating the telephone</b>	<b>17</b>
4.1	Setting the display language	17
4.2	Setting the date and time	18
4.3	Setting the time format	18
4.4	Outgoing calls	19
4.5	Activating/deactivating hands free mode	20
4.6	Mute	20
4.7	Setting the speaker and receiver volume	20
4.8	Activating and deactivating the keypad beep	20
4.9	Phone book	20
4.10	Abbreviated dialling keys	21
4.11	Setting the internal / external ring tone	22
4.12	Setting the ring tone volume	22
4.13	Setting the dialling mode	22
4.14	Setting the system PIN	23
4.15	Resetting the base station	23
4.16	The calls list	24
4.17	Making an internal call to a handset and forwarding a call to the cordless handset	25
4.18	Finding the handset (paging function)	26
4.19	The R key (Flash)	26

<b>5 Using the cordless handset .....</b>	<b>26</b>
5.1 Changing the language .....	26
5.2 Outgoing calls .....	27
5.3 Incoming calls .....	28
5.4 Activating/deactivating hands free mode .....	28
5.5 Mute .....	28
5.6 Setting the earpiece/hands free volume.....	28
5.7 The R key (Flash).....	29
5.8 Selecting the ring tone and setting the volume .....	29
5.9 Key lock.....	30
5.10 Handset name.....	30
5.11 Activate / deactivate keypad beep .....	30
5.12 Phone book .....	31
5.13 Caller ID (CLIP).....	32
5.14 Resetting the handset to default settings. ....	34
5.15 Voicemail display .....	34
<b>6 Registering and de-registering a handset .....</b>	<b>34</b>
6.1 Registering a handset to the Cocoon 8410 base station .....	34
6.2 De-registering a handset from the Cocoon 8410 base station .....	35
6.3 De-registering a handset from the Cocoon 8410 base station via the handset .....	36
6.4 Selecting a base station .....	36
<b>7 Call forwarding and internal calls from one handset to another.....</b>	<b>37</b>
7.1 Call forwarding and conference calls during an external call .....	37
7.2 Internal call (house phone function) .....	38
<b>8 Abbreviations and technical terms .....</b>	<b>38</b>
<b>9 Troubleshooting .....</b>	<b>39</b>
<b>10 Servicing .....</b>	<b>40</b>
10.1 Maintenance.....	40
10.2 Cleaning .....	41
10.3 Decommissioning, storage.....	41
10.4 Disposal (environmental protection).....	41
<b>11 Technical data .....</b>	<b>42</b>
<b>12 Warranty.....</b>	<b>43</b>
12.1 Warranty period.....	43
12.2 Warranty claim handling.....	43
12.3 Warranty exclusions.....	43
<b>13 Customer service address and support .....</b>	<b>44</b>
<b>14 Conformity and manufacturer.....</b>	<b>44</b>
<b>15 Index.....</b>	<b>45</b>

# 1 General information

This User Guide contains all the information you need to install, set up and operate your device. It also contains information and important notes for your safety and help in the event of problems.

Always keep the User Guide near the device.

Keep this User Guide in a safe place and pass it on to another user if necessary.

## 1.1 The product: Cocoon 8410

This product has been manufactured in accordance with the uniform digital standard for cordless telephones (DECT). DECT technology features a high level of security against interception as well as high-quality digital transmission. This telephone is intended for various applications, for example on a network of base stations and cordless handsets that make up a complete PBX: up to 5 cordless handsets can be operated on one base station and one cordless handset can be operated on up to 4 base stations. Internal calls can be made between the base station and handset or between two handsets.

If available on your line, caller ID and SMS services from your telephone service provider are possible on this telephone. If you use these services, the caller's telephone number is shown in the telephone display.







**Important** To use "Caller ID", this feature must first be enabled for your telephone line. Contact your telephone line provider for information about activating this feature. If this feature is not enabled, the numbers from which incoming calls originate will NOT be shown in the telephone display.

## 1.2 Copyright

This document is protected by copyright.

All rights, including those of total or partial photomechanical reproduction, duplication and distribution by means of particular processes (such as data processing, data carriers and data networks), and substantive and technical changes, are reserved.

### 1.3 Signal words and symbols

Symbol	Signal word	Meaning
	<b>Warning</b>	Warning of risk of potential serious injury or death if you fail to comply with this information.
	<b>Caution</b>	Warning of risk of potential minor injury if you fail to comply with this information.
none	<b>Caution</b>	Risk of material or environmental damage.
	<b>Important</b>	This provides important information about the function.
	<b>Info, tip</b>	General information or particular tips.

### 1.4 Intended use

This product is intended for making telephone calls via a fixed line within a telephone network. The pre-requisite for proper use of the phone is professional installation taking account of the information in this User Guide.

Any other use is deemed improper and is not permitted.

Any modifications or conversions by the user that are not described in this User Guide, are deemed improper and are not permitted. We accept no liability for any damage that may arise from these.

### 1.5 Contents of box

Check that the contents of the box are complete and undamaged. Contact your dealer immediately if parts are missing or defective. Keep the packaging in case you need to return the telephone or send it for repair.

- 1 Base station with receiver and connecting cable
- 1 Mains adapter for base station
- 1 Telephone cable for base station
- 1 Charging station incl. mains adapter
- 1 Cordless handset incl. 2 rechargeable batteries (AAA, 1.2 V / 450 mAh, NiMH) and a battery compartment cover
- 1 User Guide



**Warning** Risk of suffocation for children! Keep packaging films out of the reach of children.



**Important** Dispose of packaging material in an environmentally responsible way!

## 2 Safety notes

The following basic safety notes must always be taken into account when using electrical devices.

Carefully read the following safety notes and details on the correct use of the device. Familiarise yourself with all the functions of the device. Keep this User Guide in a safe place near the device and pass it on to another user if necessary. Do not pass the telephone on to third parties without the User Guide.

### Electrical risks:



**Warning** Risk of injury or death due to electrical current! In the event of danger, disconnect the device from the 230 V mains immediately.

- Do not use the device if the mains adapter, cable or device are damaged. Take care not to drop the device as it could be damaged.
- The voltage within the device is at hazardous levels. Never open the casing or insert object through the ventilation slot.
- Prevent liquids penetrating the device. If this should occur, unplug the mains adapter from the power socket and the telephone cable connector from the wall socket.
- Also unplug the mains adapter from the power socket and the telephone cable connector from the wall socket if faults occur during operation and before cleaning the device.
- Do not touch the charger and plug connectors with sharp or metal objects.
- Do not modify or repair the device. The device or cable should only be repaired by a specialist in the service centre. Repairs that are not carried out properly can cause significant risks to the user.
- Children frequently underestimate the dangers of handling electrical devices. Never allow children near electrical devices unsupervised.
- Do not allow children to play with the devices or their parts.

**Caution** Possible damage to the device. In the event of danger, disconnect the device from the 230 V mains immediately.

- Do not use the device in humid areas (e.g. bathroom) or very dusty areas.
- Devices connected to the mains may be damaged during thunderstorms. Therefore always unplug the device in a thunderstorm.
- The mains adapter must be completely removed from the socket to disconnect the device fully from the power supply. Always pull the plug and never the cable.
- Check cables regularly for damage, protect them against hot surfaces and other hazards, unwind them fully, lay them so that nobody can trip over them and do not constrict them.

### Fire risks:



**Warning** Risk of injury or death due to fire!  
Do not expose the device to excessive heat and disconnect it from the 230 V mains supply immediately in the event of danger.

The heat generated inside the device may cause a fault or a fire in the device. Therefore do not expose this device to extreme temperatures:

- Avoid direct sunlight and heat
- Do not cover the ventilation slot on the device

### Risk of explosion:



**Warning** Risk of injury due to explosion!  
Exercise particular caution in respect of children!

- Never throw disposable or rechargeable batteries into fire.
- Do not operate the device in an environment with a risk of explosions!

### Risk of poisoning:



**Warning** Risk of injury due to poisoning!  
Exercise particular caution in respect of children!

- Keep disposable and rechargeable batteries out of the reach of children.

## Risk of suffocation:



**Warning** Risk of injury due to suffocation!  
Exercise particular caution in respect of children!

- Keep packaging films out of the reach of children.
- Consider possible risks to children (risk of strangulation) if you use extension cables.

## Faults:



**Warning** Possible risk of injury due to faults in the device!  
Exercise particular caution in respect of medical equipment.

- The function of medical electrical devices may be affected by electromagnetic radiation from your device. Therefore make sure that the device is installed and operated sufficiently far away from medical electrical devices.  
The same applies to implanted medical devices such as pacemakers.
- The cordless handset may cause an unpleasant buzz in hearing aids so keep it sufficiently far away from hearing aids.

## Possible damage:

**Caution** Possible damage to the device! Read the information in this User Guide.

- Only use the supplied main adapters. Do not use any third-party adapters as the rechargeable batteries could be damaged.
- The socket for connecting the mains adapter must be near the device and easily accessible.
- Only use the supplied rechargeable batteries. When they need to be replaced, use rechargeable batteries of the same type. Make sure the batteries are inserted the right way round (information can be found in the battery compartment on the device). Never use ordinary disposable batteries!



**Important** In the event of a power failure, it is only possible to make calls using the base station.

## 2.1 Notes on low-radiation operation

This cordless telephone (compliant with the DECT standard) facilitates low-radiation operation (ECO mode).

During a call, the handset reduces the radio output depending on the distance from the base station. When no call is being conducted, the handset reduces the radio output to a minimum. This does not mean that normal DECT radiation is harmful to health. Rather, low-radiation operation avoids any unnecessary radiation exposure.

The base does not reduce radio output! Set up the base station in a location where you do not spend much time, for example in the hallway. Avoid setting it up in your or your children's bedrooms or the lounge.

## 3 First steps

### 3.1 How to use this User Guide

The following method is used in this User Guide to clarify instructions:

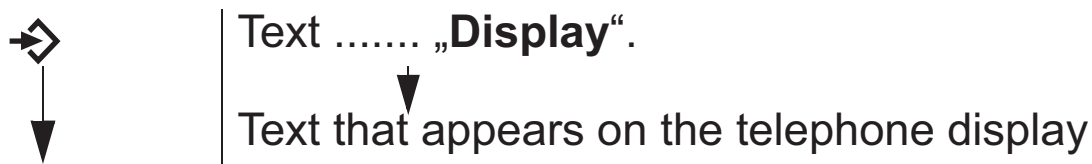

Key to be pressed

### 3.2 Installing the base station

Install the base station as follows:

- 1 Connect the mains adapter to the base station first and then to a socket.
- 2 Connect one end of the telephone cable to the telephone socket on the wall and the other to the connector on the back of the base station.
- 3 The telephone and power cables should be connected as shown in figure 3A.

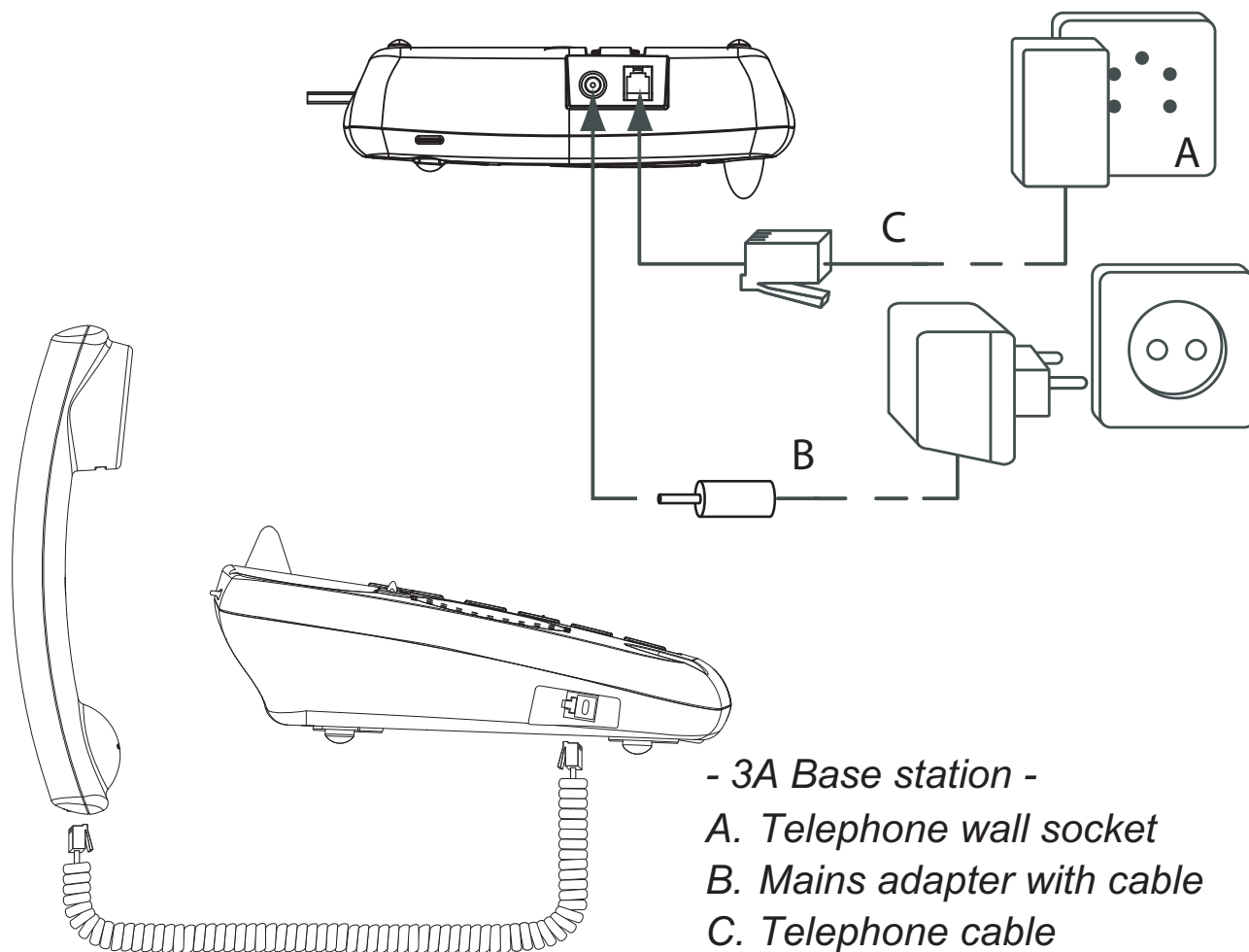

### 3.3 Handset charger

- 1 Plug the mains adapter into a power socket.

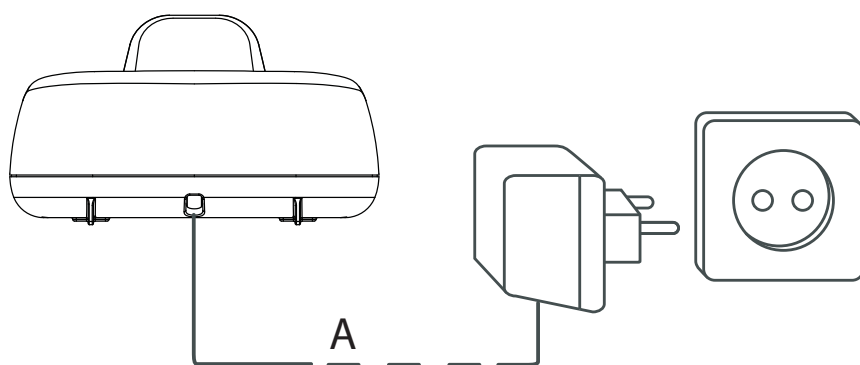

- 3B Charger -  
 A. Mains adapter with cable

### 3.4 Handset



**Caution** Risk of injury due to explosion!  
 Only use the supplied rechargeable batteries or batteries of a similar type. Do not use ordinary disposable batteries!  
 Otherwise the cordless handset may be damaged.

- 1 Open the battery compartment as shown in figure 3C.
- 2 Insert the rechargeable batteries. Make sure the polarity is correct (+ and -).
- 3 Close the battery compartment.
- 4 Place the handset in the charger and charge it for 16 hours. The charging LED is illuminated

- 3C Back of the handset -

A. Cover

B. Rechargeable batteries

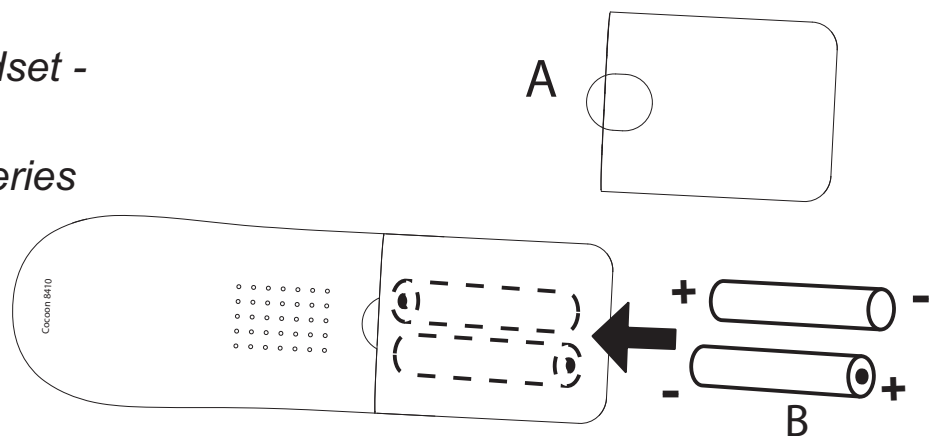

### 3.5 Wall mounting

You can fix the base station to the wall using 2 screws, 100 mm apart. To hang the receiver on the base station, the insert (no. 32 in figure 3F „Base station“ on page 14) must be turned 180° as shown.

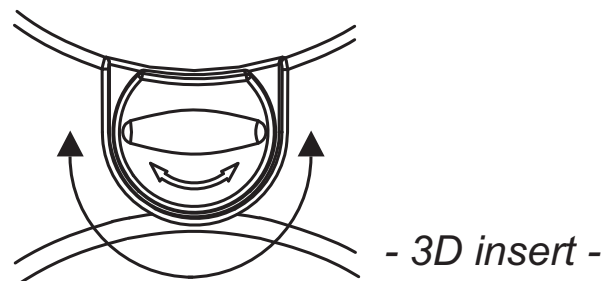

100 mm



### 3.6 Battery status display

The handset will stop working when the batteries are flat. If the batteries are completely flat and you place the handset on the base station for just a short time, the battery charge indicator will show that they are full. However they are not and the battery performance will deteriorate rapidly. You must leave the handset on the charger for 16 hours to charge batteries fully.



Charged batteries



Flat batteries

The handset will emit a warning tone when the batteries are nearly flat during a call. Place the handset on the handset charger to recharge the batteries.

### 3.7 Keys/Display

#### Cordless handset

1. Redial / Up
2. Phone book
3. Mute / Delete
4. Hang up
5. Alphanumeric keys
6. Key lock
7. Pause
8. Ringer ON/OFF
9. Calls list / Down
10. Answer call / Hands free / Call button
11. INT / Escape
12. Menu / OK / Flash
13. Display
14. Red LED, flashes during a call

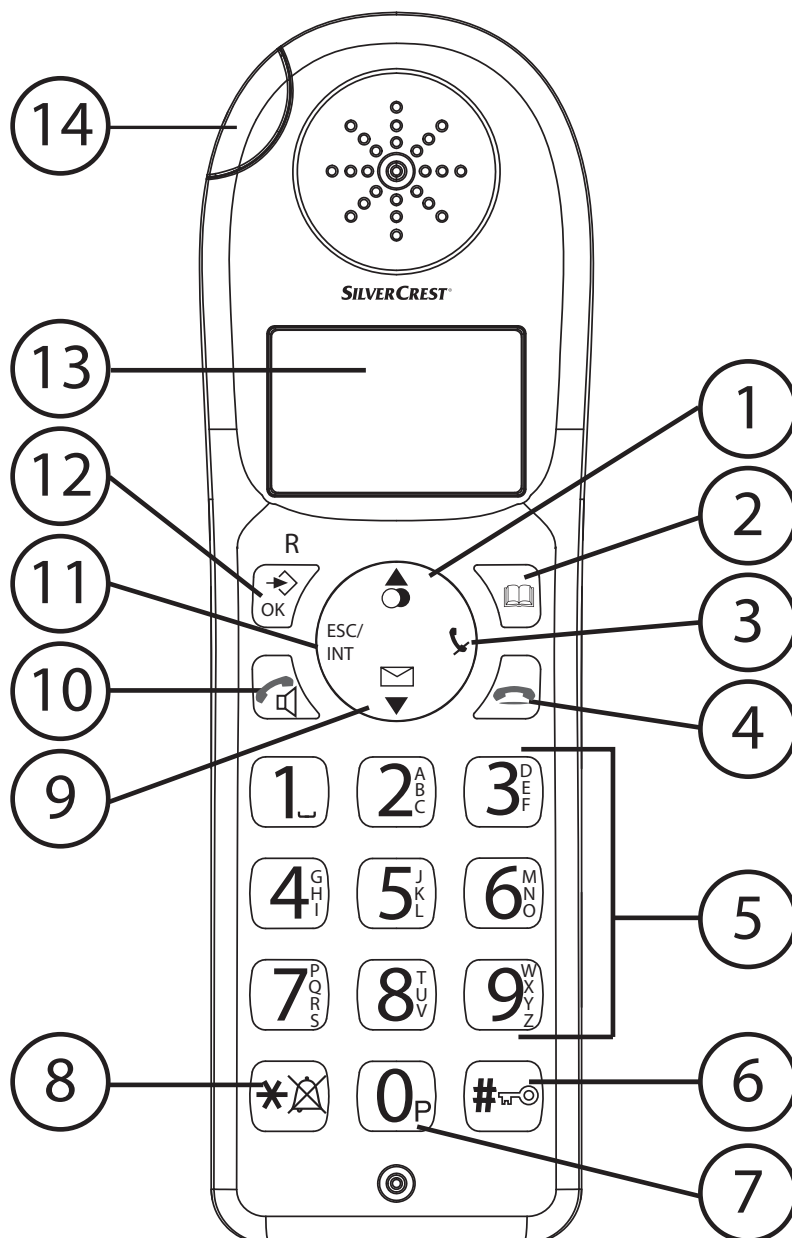

- 3E Front of the handset -

## Base station

- 15. Escape
- 16. Menu / OK
- 17. Left
- 18. Redial / Up
- 19. Right
- 20. Display
- 21. Phone book
- 22. Calls list / Flash
- 23. Down
- 24. Abbreviated dialling (M1 - M2 - M3)
- 25. Hands free
- 26. Alphanumeric keys
- 27. Red LED on the base station, flashes during a call

- 28. Paging / Call diversion Internal call
- 29. Mute / Delete
- 30. Volume control
- 31. Loudspeaker
- 32. Receiver holder for wall mounting
- 33. Lug: for putting down the receiver briefly during a call when the phone is wall-mounted

## Charger

- 34. LED: Handset charging in progress.

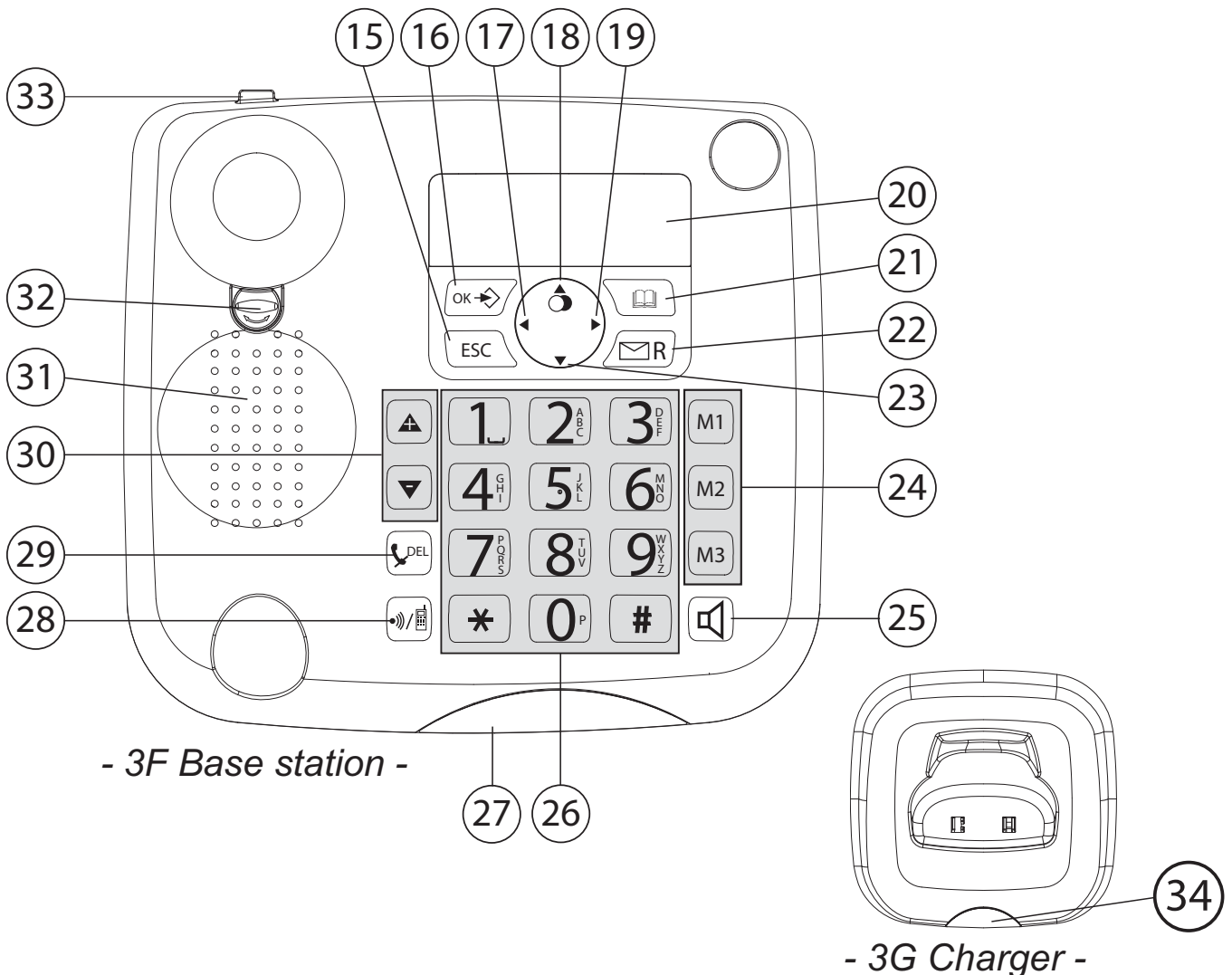

## 3.8 Handset display



HANDSET X X = handset number



Other numbers or scroll left through the menu



Other numbers or scroll right through the menu



Find or create phone book entries



Battery status display



Ringer off



Hands free mode on



Key lock on



New voicemail message



Call created



Microphone muted



New numbers in the calls list



The antenna indicates the strength of the reception signal. The antenna flashes when the handset is out of range.



Internal call

## 3.9 Base station display



Other numbers or scroll left through the menu



Other numbers or scroll right through the menu



Ringer off



New voicemail message

CLIP

New numbers in the calls list

04

Item number in the calls list



Find or create phone book entries



Hands free mode on

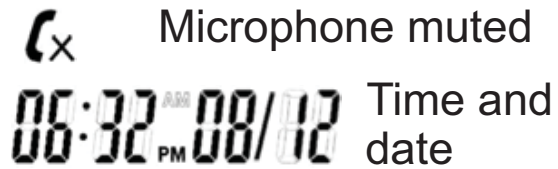
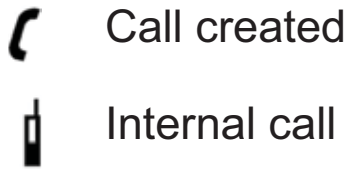

### 3.10 Navigating through the menu

The Cocoon 8410 has an easy-to-use menu system. Every menu consists of a series of options.

A summary of the menus on the handset and base station can be found below.

- |                                              |                                                                                                                                                                                                                                                                                                                  |
|----------------------------------------------|------------------------------------------------------------------------------------------------------------------------------------------------------------------------------------------------------------------------------------------------------------------------------------------------------------------|
| <p>→ OK</p> <p>▲▼</p> <p>→ OK</p> <p>ESC</p> | <ol style="list-style-type: none"> <li>1 Press the Menu/OK key to open the main menu.</li> <li>2 Scroll to the required menu option.</li> <li>3 Press the Menu/OK key to open more options or to confirm the displayed setting.</li> <li>4 Press the Escape key to go back to the previous menu level</li> </ol> |
|----------------------------------------------|------------------------------------------------------------------------------------------------------------------------------------------------------------------------------------------------------------------------------------------------------------------------------------------------------------------|

#### Handset

PHONE BOOK	
HANDSET	RING TONE HANDSET NAME KEYPAD BEEP SELECT BASE RESET LANGUAGE
REGISTER	
DE-REGISTER	

#### Base station

PHONE BOOK	
RING TONE	EXTERNAL INTERNAL VOLUME
KEYPAD BEEP	
LANGUAGE	
SETTINGS	DIAL MODE RECALL SYSTEM PIN
TIME	DATE/TIME FORMAT
REMOVE HS	
RESET	

### 3.11 Using the alphanumeric keys

You can use the alphanumeric keys to enter text. Press the appropriate alphanumeric key to select a letter<sup>②⑥</sup>. For example, if you press the **5** numeric key, the letter 'j' appears in the display first. Press the key several times to select the other letters.

Press the **2** key once to select the letter "a". If you want to enter the letters "a" and "b" in succession, first press the **2** key once to select the letter "a". Wait 2 seconds until the cursor has moved to the next position. Now press the **2** key twice to select "b". You can use the delete key  <sup>②⑨</sup> to delete letters that have been entered incorrectly. The letter before the cursor is deleted.

Use the Left/Right key  <sup>①⑦</sup> /  <sup>①⑨</sup> to move the cursor.

#### Table of characters

1	Space+ - / 1
2	A B C 2
3	D E F 3
4	G H I 4
5	J K L 5
6	M N O 6
7	P Q R S 7
8	T U V 8
9	W X Y Z 9
0	_ 0



## 4 Operating the telephone



### Info

This section only describes the functions of the base station! Information on using the handset can be found in „5 Using the cordless handset“.

### 4.1 Setting the display language

- |                                                                                        |                                                  |
|----------------------------------------------------------------------------------------|--------------------------------------------------|
|  OK | <b>1</b> Press the Menu / OK key.                |
|  OK | <b>2</b> Select " <b>LANGUAGE</b> " and confirm. |
|     | <b>3</b> Now select the language.                |
| OK                                                                                     | <b>4</b> Press OK to confirm.                    |

## 4.2 Setting the date and time



### Info

If caller ID (**CLIP**) is activated on your telephone line and the provider transmits the date and time, the clock is set automatically when an incoming call is received.

When you have set the time, it will be adopted by all handsets registered to the base station.

- |                                                 |   |                                          |
|-------------------------------------------------|---|------------------------------------------|
| → OK                                            | 1 | Press the Menu / OK key.                 |
| ▲▼ OK                                           | 2 | Select " <b>TIME</b> " and confirm.      |
| ▲▼ OK                                           | 3 | Select " <b>DATE/TIME</b> " and confirm. |
| 4 <sup>h</sup> 5 <sup>m</sup> 6 <sup>h</sup> OK | 4 | Enter the year and confirm.              |
| 4 <sup>h</sup> 5 <sup>m</sup> 6 <sup>h</sup> OK | 5 | Enter the month and confirm.             |
| 4 <sup>h</sup> 5 <sup>m</sup> 6 <sup>h</sup> OK | 6 | Enter the day and confirm.               |
| 4 <sup>h</sup> 5 <sup>m</sup> 6 <sup>h</sup> OK | 7 | Enter the hours and confirm.             |
| 4 <sup>h</sup> 5 <sup>m</sup> 6 <sup>h</sup>    | 8 | Enter the minutes.                       |
| OK                                              | 9 | Press OK to confirm.                     |



**Important** The date and time will be lost in the event of a base station power failure.

## 4.3 Setting the time format

- |       |   |                                                                                 |
|-------|---|---------------------------------------------------------------------------------|
| → OK  | 1 | Press the Menu / OK key.                                                        |
| ▲▼ OK | 2 | Select " <b>TIME</b> " and confirm.                                             |
| ▲▼ OK | 3 | Select " <b>FORMAT</b> " and confirm.                                           |
| ▲▼ OK | 4 | Select the time format as " <b>24 HOUR</b> " or " <b>12 HOUR</b> " and confirm. |

## 4.4 Outgoing calls

### Making a call



- 1 Lift the receiver or press the hands free key.
- 2 Enter the telephone number.
- 3 Hang up the receiver or press the hands free key again to end the call.

OR



- 1 Enter the telephone number.
- 2 Lift the receiver or press the hands free key.
- 3 Hang up the receiver or press the hands free key again to end the call.

### Redialling the last telephone number called



- 1 Lift the receiver or press the hands free key.
  - 2 Press the redial key.
- The last telephone number is automatically dialled.

### Redialling one of the last 3 telephone numbers called



- 1 Press the redial key.
- 2 Select one of the last 3 numbers dialled.
- 3 Lift the receiver or press the hands free key.

### Calling a number in the phone book



- 1 Press the phone book key.
  - 2 Scroll to the required name or enter the initial letters of the name.
  - 3 Press the Menu / OK key to display the telephone number.
  - 4 Lift the receiver or press the hands free key.
- The telephone number is automatically dialled.

## 4.5 Activating/deactivating hands free mode

You can use this function to answer a call without having to lift the receiver or if the receiver has already been lifted.



1 Press the hands free key to activate the function.



2 Press the hands free key again to switch the call back to the receiver.

## 4.6 Mute

The microphone can be muted during a call so that you can talk without being overheard by the person on the other end of the line.



1 Press the mute key.

The microphone is muted.



2 Press the mute key again to reactivate the microphone.

## 4.7 Setting the speaker and receiver volume



1 Press the volume key during a call.

2 You can set the volume to levels 1 to 5.

## 4.8 Activating and deactivating the keypad beep



1 Press the Menu / OK key.



OK

2 Select "**KEYPAD BEEP**" and confirm.



OK

3 Select "**ON**" or "**OFF**" and confirm.

## 4.9 Phone book

50 telephone numbers and names can be stored in the phone book. Names may be up to 16 characters long and numbers up to 24 digits long.

### Adding a new name and number



1 Press the phone book key.

OK

2 Press OK.



OK

3 Select "**NEW ENTRY**" and confirm.



OK

4 Enter the name and confirm.







OK





5 Enter the telephone number and confirm.

6 A confirmation tone is now sounded.

## Editing the name and telephone number

- |                                                                                   |    |                                                                                                      |
|-----------------------------------------------------------------------------------|----|------------------------------------------------------------------------------------------------------|
|  |    | <b>1</b> Press the phone book key.                                                                   |
|  |    | <b>2</b> Select the name using the up and down keys.<br>OR<br>Enter the initial letters of the name. |
| OK                                                                                |    | <b>3</b> Press OK.                                                                                   |
|  | OK | <b>4</b> Select <b>"EDIT ENTRY"</b> and confirm.                                                     |
| DEL                                                                               |    | <b>5</b> Press the delete key to delete the letters.                                                 |
|  | OK | <b>6</b> Enter the name and confirm.                                                                 |
|  | OK | <b>7</b> Enter the telephone number and confirm.                                                     |
|                                                                                   |    | <b>8</b> A confirmation tone is now sounded.                                                         |



## Deleting one entry or all entries in the phone book

- |                                                                                     |     |                                                                                                      |
|-------------------------------------------------------------------------------------|-----|------------------------------------------------------------------------------------------------------|
|    |     | <b>1</b> Press the phone book key.                                                                   |
|    |     | <b>2</b> Select the name using the up and down keys.<br>OR<br>Enter the initial letters of the name. |
|  |     | <b>3</b> Press OK.                                                                                   |
| OK                                                                                  |     | <b>4</b> Select <b>"DELETE ENTRY"</b> or <b>"DELETE ALL"</b> and confirm.                            |
|  | OK  |                                                                                                      |
| OK                                                                                  | ESC | <b>5</b> Press OK to confirm or press the Escape key to go back.                                     |

## 4.10 Abbreviated dialling keys

You can store 3 direct abbreviated numbers M1, M2 and M3 (each up to 24 digits) in the base station.

### Saving direct abbreviated dialling numbers (M1 - M2 - M3)

- |                                                                                     |    |                                                                                         |
|-------------------------------------------------------------------------------------|----|-----------------------------------------------------------------------------------------|
| <b>M1-M2-M3</b>                                                                     |    | <b>1</b> Press one of the abbreviated dialling keys.                                    |
| OK                                                                                  |    | <b>2</b> Press OK.                                                                      |
|  | OK | <b>3</b> Select <b>"NEW ENTRY"</b> and confirm.                                         |
|  | OK | <b>4</b> Enter the name and confirm.                                                    |
|  | OK | <b>5</b> Enter the telephone number and confirm.<br>A confirmation tone is now sounded. |





## Info

To save a pause in the telephone number, press the pause key 'P' (key 26 in figure 3F „Base station“ on page 14) for 2 seconds at the place where you want to inserted a 3 -second pause.

Abbreviated dialling numbers can be edited or deleted in the same way described for the phone book above.





Unassigned abbreviated dialling keys are displayed as **"EMPTY"**.

### Dialling an abbreviated number





- |                                                                                                      |                                                                                                                                                                                                         |
|------------------------------------------------------------------------------------------------------|---------------------------------------------------------------------------------------------------------------------------------------------------------------------------------------------------------|
| <br><b>M1-M2-M3</b> | <ol style="list-style-type: none"> <li>1 Lift the receiver or press the hands free key.</li> <li>2 Press the abbreviated dialling key.</li> </ol> <p>The telephone number is automatically dialled.</p> |
|                     | <ol style="list-style-type: none"> <li>3 Hang up the receiver or press the hands free key again to end the call.</li> </ol>                                                                             |

### 4.11 Setting the internal / external ring tone

There are 9 different ring tones available (1 - 9).

- |                                                                                        |                                                                                                            |
|----------------------------------------------------------------------------------------|------------------------------------------------------------------------------------------------------------|
|  OK | <ol style="list-style-type: none"> <li>1 Press the Menu / OK key.</li> </ol>                               |
|     | <ol style="list-style-type: none"> <li>2 Select <b>"RING TONE"</b> and confirm.</li> </ol>                 |
|     | <ol style="list-style-type: none"> <li>3 Select <b>"INTERNAL"</b> for internal calls.</li> </ol> <p>OR</p> |
|     | <ol style="list-style-type: none"> <li>4 Select <b>"EXTERNAL"</b> for incoming external calls.</li> </ol>  |
|  OK | <ol style="list-style-type: none"> <li>5 Now select a ring tone (1 to 9) and confirm.</li> </ol>           |

### 4.12 Setting the ring tone volume

- |                                                                                        |                                                                                                        |
|----------------------------------------------------------------------------------------|--------------------------------------------------------------------------------------------------------|
|  OK | <ol style="list-style-type: none"> <li>1 Press the Menu / OK key.</li> </ol>                           |
|  OK | <ol style="list-style-type: none"> <li>2 Select <b>"RING TONE"</b> and confirm.</li> </ol>             |
|  OK | <ol style="list-style-type: none"> <li>3 Select <b>"VOLUME"</b> and confirm.</li> </ol>                |
|  OK | <ol style="list-style-type: none"> <li>4 Select the required volume (Off, 1-5) and confirm.</li> </ol> |

### 4.13 Setting the dialling mode

There are two dialling modes for telephone connections:

- DTMF / tone dialling (most common)
- Pulse dialling mode (only necessary if this devices is operated on an older PBX!)

- |       |   |                                                         |
|-------|---|---------------------------------------------------------|
| → OK  | 1 | Press the Menu / OK key.                                |
| ▲▼ OK | 2 | Select " <b>SETTINGS</b> " and confirm.                 |
| ▲▼ OK | 3 | Select " <b>DIAL MODE</b> " and confirm.                |
| ▲▼ OK | 4 | Select " <b>TONE</b> " or " <b>PULSE</b> " and confirm. |

#### 4.14 Setting the system PIN

Some functions are only available if you know the PIN code for the base station.

The PIN code is 4 characters long. The default PIN code is "0000". Proceed as follows to change the PIN code and set your own PIN:

- |                                                 |   |                                            |
|-------------------------------------------------|---|--------------------------------------------|
| → OK                                            | 1 | Press the Menu / OK key.                   |
| ▲▼ OK                                           | 2 | Select " <b>SETTINGS</b> " and confirm.    |
| ▲▼ OK                                           | 3 | Select " <b>SYSTEM PIN</b> " and confirm.  |
| 4 <sup>a</sup> 5 <sup>b</sup> 6 <sup>c</sup> OK | 4 | Enter the " <b>OLD PIN</b> " and press OK. |
| 4 <sup>a</sup> 5 <sup>b</sup> 6 <sup>c</sup> OK | 5 | Enter the " <b>NEW PIN</b> " and confirm.  |

#### 4.15 Resetting the base station

You can reset all the settings on the base station and delete all entries in the phone book, calls list, VIP list and redial list.

To restore the default settings:

- |                                                 |   |                                        |
|-------------------------------------------------|---|----------------------------------------|
| → OK                                            | 1 | Press the Menu / OK key.               |
| ▲▼ OK                                           | 2 | Select " <b>RESET</b> " and confirm.   |
| OK                                              | 3 | Press OK to confirm.                   |
| 4 <sup>a</sup> 5 <sup>b</sup> 6 <sup>c</sup> OK | 4 | Enter the PIN code (0000) and confirm. |

#### The default settings are:

- |                        |      |
|------------------------|------|
| - External ring tone   | 8    |
| - Internal ring tone   | 1    |
| - Ring tone volume     | 3    |
| - Keypad beep          | ON   |
| - Dial mode            | TONE |
| - Earpiece volume      | 3    |
| - Hands free volume    | 3    |
| - Date and time format | 24   |



**Important** All the stored data (redial, phone book, call list, abbreviated numbers) will be deleted.

## 4.16 The call list

Incoming calls are stored in a calls list (max. 30 numbers) on the base station and the handsets.

The number of missed calls is shown by "**X MISSED**"

(X = number of missed calls) and the flashing **CLIP** symbol. Briefly press the calls list key  to display the last call.



**Important** The "caller ID" (**CLIP**) feature is only available if it is activated for your line. Contact your telephone line provider for additional information.

The telephone number and name of the last caller appear in the display. If the telephone number is longer than 12 digits, you can show the remaining digits by pressing the  key. If the calls list is empty, the word "**EMPTY**" appears in the display.

The date and time of the incoming call are displayed at the top right for every call.



- 1 Press the up and down keys to scroll through the list.

The position number of the call in the calls list appears next to the **CLIP** symbol.



- 2 Press the left and right keys to display the name or number.



### Info





The phone reverts to standby mode if neither the up or down key  is pressed within 15 seconds. When a call is received, the caller's number is shown in the display for another 5-8 seconds after the last ring.

## Calling a number in the call list





- 1 Press the calls list key.
- 2 Press the up and down keys to scroll through the list.
- 3 Pick up the receiver or press the hands free key again to make the call.

## Storing a number in the phone book or as an abbreviated dialling number under M1 to M3.

- |                                                                                   |    |          |                                                                                    |
|-----------------------------------------------------------------------------------|----|----------|------------------------------------------------------------------------------------|
|  |    | <b>1</b> | Press the calls list key.                                                          |
|  |    | <b>2</b> | Press the up and down keys to scroll through the list and confirm.                 |
| OK                                                                                |    |          |                                                                                    |
|  |    | <b>3</b> | Select " <b>SAVE TO PB</b> " or " <b>SAVE TO MX</b> " (MX = M1 to M3) and confirm. |
| OK                                                                                |    |          |                                                                                    |
|  |    | <b>4</b> | You can now enter or edit the name and then confirm.                               |
| OK                                                                                |    |          |                                                                                    |
|  | OK | <b>5</b> | Enter or edit the telephone number and confirm.                                    |

## Deleting one entry or all entries in the calls list.







- |                                                                                   |    |          |                                                                            |
|-----------------------------------------------------------------------------------|----|----------|----------------------------------------------------------------------------|
|  |    | <b>1</b> | Press the calls list key.                                                  |
|  |    | <b>2</b> | Press the up and down keys to scroll through the list and confirm.         |
| OK                                                                                |    |          |                                                                            |
|  |    | <b>3</b> | Select " <b>DELETE ENTRY</b> " or " <b>DELETE ALL</b> " and confirm twice. |
| OK                                                                                | OK |          |                                                                            |



**Important** Only old calls will be deleted. New calls that have not been viewed or were unanswered will be kept.

## 4.17 Making an internal call to a handset and forwarding a call to the cordless handset

You can forward a call from the base station to the handset or talk to the external subscriber and a second subscriber on the cordless handset at the same time (conference call).

- |                                                                                     |  |          |                                                                                                                                                                                                                      |
|-------------------------------------------------------------------------------------|--|----------|----------------------------------------------------------------------------------------------------------------------------------------------------------------------------------------------------------------------|
|  |  | <b>1</b> | Hold down the INT key  for 3 seconds until you hear an audio signal, then release the key. " <b>INT</b> " appears in the display. |
|  |  | <b>2</b> | Enter the number of the handset. Once the call has been set up with the handset, you can talk internally.                                                                                                            |
|  |  | <b>3</b> | Put the receiver down to transfer the call to the cordless handset.<br>OR                                                                                                                                            |
|  |  | <b>4</b> | Hold down the INT key  for 3 seconds to set up a conference call.                                                                 |

## 4.18 Finding the handset (paging function)

You can use this function to locate your handset.



- 1 Press the paging key on the base station.  
The handset will ring for 30 seconds and the red LED on the handset will flash.
- 2 Press any key on the handset to stop it ringing.

## 4.19 The R key (Flash)

Press the Flash key on the base station (key 22 in figure 3F on page 14) to use special services on your external line such as "call waiting" (providing your telephone line provider offers this service) or to forward a call when you are using a PBX. The flash key **R** briefly interrupts your call. You can set this interruption time to 100 ms or 300 ms. However, if your system requires a longer flash time, you can change this.



- |    |                                                               |
|----|---------------------------------------------------------------|
| OK | 1 Press the Menu / OK key.                                    |
| OK | 2 Select " <b>SETTINGS</b> " and confirm.                     |
| OK | 3 Select " <b>RECALL</b> " and confirm.                       |
| OK | 4 Now select " <b>LONG</b> " or " <b>SHORT</b> " and confirm. |

## 5 Using the cordless handset



### Info

This section only describes the functions of the cordless handset! Information on using the base station can be found in „4 Operating the telephone“.

### 5.1 Changing the language



ESC

- |     |                                                |
|-----|------------------------------------------------|
| OK  | 1 Press the Menu / OK key.                     |
| OK  | 2 Select " <b>HANDSET</b> " and confirm.       |
| OK  | 3 Select " <b>LANGUAGE</b> " and confirm.      |
| OK  | 4 Select the desired language and confirm.     |
| ESC | 5 Press the Esc key to return to standby mode. |

## 5.2 Outgoing calls

### Making a call



- 1 Press the call button.
- 2 Enter the telephone number.
- 3 Press the hang up key to end the call.

### Call preparation



- 1 Enter the telephone number.  
You can correct a wrong number using the mute key. If you do not press any key for 10 seconds, the number disappears and the handset reverts to standby mode.
- 2 Press the call button.  
The telephone number is automatically dialled.
- 3 Press the hang up key to end the call.

### Redialling the last telephone number called



- 1 Press the call button.
- 2 Press the redial button.  
The last telephone number is automatically dialled.
- 3 Press the hang up key to end the call.

### Redialling one of the last 3 telephone numbers called



- 1 Press the redial key.  
The last number called appears in the display.  
If you want to redial one of the last 3 numbers, keep pressing the redial key until the number you want appears in the display.
- 2 Press the call button.  
The telephone number is automatically dialled.
- 3 Press the hang up key to end the call.

### 5.3 Incoming calls

When an incoming call is received, the handset and the base station ring and the "Visual call signal" LED (see point 14 in figure 3E and point 27 in figure 3F) flashes on the handset and base station.



- 1 Press the answer call key to answer the call.
- 2 Press the hang up key to end the call.

### 5.4 Activating/deactivating hands free mode

You can use this function to answer a call without having to hold the handset or if the a call is already being conducted on the handset. During the call:



- 1 Press the hands free key to activate the function.
- 2 Press the hands free key again to switch the call back to the handset.



**Important** The batteries discharge more quickly if you use hands free mode for a long time!

### 5.5 Mute

The microphone can be muted during a call so that you can talk without being overheard by the person on the other end of the line.



- 1 Press the mute key.  
The microphone is muted and **"MUTED"** is displayed.



- 2 Press the mute key again to reactivate the microphone.

### 5.6 Setting the earpiece/hands free volume

During a call:



- 1 Press the down keys.
- 2 Press the up or down key to set the volume.  
You can set the volume to levels 1 to 5.

## 5.7 The R key (Flash)

R → OK

Press the Flash key on the base station (key12 in figure 3E „Cordless handset“ on page 13) to use special services on your external line such as "call waiting" (providing your telephone line provider offers this service) or to forward a call when you are using a PBX. The flash key **R** briefly interrupts your call. You can set this interruption time to 100 ms or 300 ms. To set a different flash time, see „4.19 The R key (Flash)“.

## 5.8 Selecting the ring tone and setting the volume



### Handset ring tone for internal/external calls

- |       |   |                                                                |
|-------|---|----------------------------------------------------------------|
| → OK  | 1 | Press the Menu / OK key.                                       |
| ▲▼ OK | 2 | Select " <b>HANDSET</b> " and confirm.                         |
| ▲▼ OK | 3 | Select " <b>RING TONE</b> " and confirm.                       |
| ▲▼ OK | 4 | Select " <b>INTERNAL</b> " or " <b>EXTERNAL</b> " and confirm. |
| ▲▼ OK | 5 | Now select a ring tone (1 to 9) and confirm.                   |

### Handset ring tone volume

- |       |   |                                                    |
|-------|---|----------------------------------------------------|
| → OK  | 1 | Press the Menu / OK key.                           |
| ▲▼ OK | 2 | Select " <b>HANDSET</b> " and confirm.             |
| ▲▼ OK | 3 | Select " <b>RING TONE</b> " and confirm.           |
| ▲▼ OK | 4 | Select " <b>VOLUME</b> " and confirm.              |
| ▲▼ OK | 5 | Select the required volume (Off, 1-5) and confirm. |



**Important** You can switch the ring tone volume of any individual handset ON or OFF by simply holding the ring tone ON/OFF key  in standby mode. The symbol  appears in the display and the ring volume is turned off.

## 5.9 Key lock

When the key lock is on, pressing any key in standby mode has no effect (with the exception of the key lock key).



1 Press and hold the key lock key.

The symbol appears in the display.



2 Press the key lock key again to deactivate key lock.



When key lock is activated, you can still answer incoming calls by pressing the answer call key. The keypad functions as usual during the call. Key lock is activated again after the call.

## 5.10 Handset name

You can change the name that appears in the display (max. 12 characters) if no call is being conducted.



1 Press the Menu / OK key.



OK

2 Select "**HANDSET**" and confirm.



OK

3 Select "**HANDSET NAME**" and confirm.



4

4 Delete the previous name using the mute key and enter a new one.

OK

5 Press to confirm.

ESC

6 Press the Esc key to return to standby mode.

## 5.11 Activate / deactivate keypad beep



1 Press the Menu / OK key.



OK

2 Select "**HANDSET**" and confirm.



OK

3 Select "**KEYPAD BEEP**" and confirm.



4 Now select "**ON**" or "**OFF**".

OK

5 Press to confirm.

ESC

6 Press the Esc key to return to standby mode.

## 5.12 Phone book

You can store 50 entries in the phone book. Names may be up to 16 characters long and telephone numbers up to 24 digits long.

### Adding a phone book entry



OK OK

4 5 6 OK

4 5 6 OK

- 1 Press the phone book key.
- 2 Press the OK key twice.
- 3 Enter the name and confirm.
- 4 Enter the desired telephone number and confirm.  
A confirmation tone is now sounded.

### Dialling an abbreviated number



4 5 6



- 1 Press the phone book key.
- 2 Scroll to the required name or enter the initial letters of the name.
- 3 Press the phone book key to display the telephone number.
- 4 Now press the call key.  
The telephone number is automatically dialled.
- 5 Press the hang up key to end the call.

### Editing a phone book entry



4 5 6



→ OK







▲ ▼ OK

4 5 6 OK

4 5 6 OK

- 1 Press the phone book key.
- 2 Scroll to the required name or enter the initial letters of the name.
- 3 Press the phone book key to display the telephone number.
- 4 Press the Menu / OK key.
- 5 Select "**EDIT ENTRY**" and confirm.
- 6 Enter the name and confirm.
- 7 Enter or edit the telephone number and confirm.

## Deleting one entry or all entries in the phone book

- |                                                                                      |                                                                                             |
|--------------------------------------------------------------------------------------|---------------------------------------------------------------------------------------------|
|     | <b>1</b> Press the phone book key.                                                          |
|     | <b>2</b> Scroll to the required name or enter the initial letters of the name.              |
|     | <b>3</b> Press the phone book key to display the telephone number.                          |
|  OK | <b>4</b> Press the Menu / OK key.                                                           |
|     | <b>5</b> Select " <b>DELETE ENTRY</b> " to delete the current phone book entry and confirm. |
| OK                                                                                   | OR                                                                                          |
|     | <b>6</b> Select " <b>DELETE ALL</b> " to delete all phone book entries and confirm.         |
| OK                                                                                   |                                                                                             |
| OK    ESC                                                                            | <b>7</b> Confirm again or press the Esc key to skip.                                        |

### 5.13 Caller ID (CLIP)

The Cocoon 8410 displays the telephone number of incoming calls. This function can only be used if you are registered for this service with your telephone line provider. Contact your provider for more information.

When you receive a call, the telephone number is stored in a calls list. This list can hold up to 30 numbers (each of up to 23 digits).



If the telephone number consists of more than 12 digits, you can scroll to the right in the display to see the other digits.

### New calls



When there is a new call received in the calls list, the **CLIP** symbol flashes in the display.

### Opening the calls list



**1** Press the calls list key.

The last call received is displayed. If the calls list is empty, the word "**EMPTY**" appears in the display.



**2** Press the phone book key to skip the number.



**3** Press the phone book key to skip the date and time.







**4** Press the up and down keys to scroll through the list.





ESC

**5** Press the Esc key to exit the calls list.







## Calling a number in the call list

- |                                                                                   |                                                                                          |
|-----------------------------------------------------------------------------------|------------------------------------------------------------------------------------------|
|  | <b>1</b> Press the calls list key.                                                       |
|  | <b>2</b> Scroll through the calls list until the telephone number you want is displayed. |
|  | <b>3</b> Press the call key to start the call.                                           |
|                                                                                   | The telephone number is automatically dialed.                                            |
|  | <b>4</b> Press the hang up key to end the call.                                          |

## Deleting a number from the call list

- |                                                                                     |                                                                                          |
|-------------------------------------------------------------------------------------|------------------------------------------------------------------------------------------|
|    | <b>1</b> Press the calls list key.                                                       |
|    | <b>2</b> Scroll through the calls list until the telephone number you want is displayed. |
|    | <b>3</b> Press the Menu / OK key.                                                        |
|    | <b>4</b> Select " <b>DELETE</b> " to delete the current telephone number and confirm.    |
| OK                                                                                  | OR                                                                                       |
|  | <b>5</b> Select " <b>DELETE ALL</b> " to delete all phone book entries and confirm.      |
| OK                                                                                  |                                                                                          |
| OK                                                                                  | <b>6</b> Press to confirm or press the Esc key to return.                                |

## Storing a number in the call list as an abbreviated dial number

- |                                                                                     |                                                                                          |
|-------------------------------------------------------------------------------------|------------------------------------------------------------------------------------------|
|  | <b>1</b> Press the calls list key.                                                       |
|  | <b>2</b> Scroll through the calls list until the telephone number you want is displayed. |
|  | <b>3</b> Press the Menu / OK key.                                                        |
|  | <b>4</b> Select " <b>SAVE TO PB</b> " and confirm.                                       |
|  | <b>5</b> Edit or add a name and then confirm.                                            |
|  | <b>6</b> Edit the telephone number and confirm.                                          |

## 5.14 Resetting the handset to default settings.



This deletes all the changes and restores all the defaults (ring tone volume, ring tone etc.). The calls list, redial list and phone book are also deleted!

- |                                                       |                                                                                                                                                                                                                                                                                               |
|-------------------------------------------------------|-----------------------------------------------------------------------------------------------------------------------------------------------------------------------------------------------------------------------------------------------------------------------------------------------|
| <p>➔ OK</p> <p>▲▼ OK</p> <p>▲▼ OK OK</p> <p>4 5 6</p> | <ol style="list-style-type: none"> <li>1 Press the Menu / OK key.</li> <li>2 Select "<b>HANDSET</b>" and confirm.</li> <li>3 Select "<b>RESET</b>" and confirm.</li> <li>4 Enter the PIN number of the base station (default 0000).</li> <li>5 The device reverts to standby mode.</li> </ol> |
|-------------------------------------------------------|-----------------------------------------------------------------------------------------------------------------------------------------------------------------------------------------------------------------------------------------------------------------------------------------------|

### The default settings are:

Handset name	HANDSET
Earpiece volume	Level 3
Ring tone volume	Level 3
External ring tone	Ring tone 8
Internal ring tone	Ring tone 1
Keypad beep	On

## 5.15 Voicemail display

This display only works if you have enabled the voicemail or telephone message service and your telephone service provider transmits this information along with the caller ID! When you receive a new message in your voicemail box, the  symbol appears in the display. The  symbol disappears when you have listened to your message.

## 6 Registering and de-registering a handset





### 6.1 Registering a handset to the Cocoon 8410 base station

You can register to 5 handsets onto one base station. Every handset is already registered to the base station on delivery.

You only need to register the handset if:

- the handset has previously been de-registered from this base station (e. g. to reinitialise it)
- you want to register a different handset to the base station.

The following description only applies to Cocoon 8410 handsets and base stations.

- |                                                                                                                                                                                                                                                                                                                                                                                                                                               |                                                                                                                                                                                                                                                                                                                                                                                                                                                                                                                                                                                                                                                                                                                                                                                                                                                                                                                                                            |
|-----------------------------------------------------------------------------------------------------------------------------------------------------------------------------------------------------------------------------------------------------------------------------------------------------------------------------------------------------------------------------------------------------------------------------------------------|------------------------------------------------------------------------------------------------------------------------------------------------------------------------------------------------------------------------------------------------------------------------------------------------------------------------------------------------------------------------------------------------------------------------------------------------------------------------------------------------------------------------------------------------------------------------------------------------------------------------------------------------------------------------------------------------------------------------------------------------------------------------------------------------------------------------------------------------------------------------------------------------------------------------------------------------------------|
| <br><br><br><br><br><br> | <ol style="list-style-type: none"> <li><b>1</b> Hold down the paging key on the base station for 10 seconds.</li> </ol> <p><b>"REGISTER"</b> is now shown in the base station display. This means that the base station is in registration mode. The handset can now be registered as follows:</p> <ol style="list-style-type: none"> <li><b>2</b> Press the Menu/OK key on the handset.</li> <li><b>3</b> Select <b>"REGISTER"</b> and confirm.</li> <li><b>4</b> Enter the number of the base station (1-4) to which you want register the handset.</li> <li><b>5</b> The device will search for the base station. When it has found it, you will be asked to enter the (four-digit) PIN code.</li> <li><b>6</b> Enter the PIN code of the base station (default 0000). If the PIN code if wrong, the handset will search for the base station again.</li> </ol> <p>Once the handset has been registered, its name and number appear on the display.</p> |
|-----------------------------------------------------------------------------------------------------------------------------------------------------------------------------------------------------------------------------------------------------------------------------------------------------------------------------------------------------------------------------------------------------------------------------------------------|------------------------------------------------------------------------------------------------------------------------------------------------------------------------------------------------------------------------------------------------------------------------------------------------------------------------------------------------------------------------------------------------------------------------------------------------------------------------------------------------------------------------------------------------------------------------------------------------------------------------------------------------------------------------------------------------------------------------------------------------------------------------------------------------------------------------------------------------------------------------------------------------------------------------------------------------------------|









**Info**

To change the base station PIN code, see „4.14 Setting the system PIN“.

## 6.2 De-registering a handset from the Cocoon 8410 base station

You can de-register a handset from a base station in order to register a different handset.

- |                                                                                                                                                                                                                                                                                                                                                                                                                                                                                                                                        |                                                                                                                                                                                                                                                                                                                                                                                                                                                                                     |
|----------------------------------------------------------------------------------------------------------------------------------------------------------------------------------------------------------------------------------------------------------------------------------------------------------------------------------------------------------------------------------------------------------------------------------------------------------------------------------------------------------------------------------------|-------------------------------------------------------------------------------------------------------------------------------------------------------------------------------------------------------------------------------------------------------------------------------------------------------------------------------------------------------------------------------------------------------------------------------------------------------------------------------------|
| <br><br><br><br><br> | <ol style="list-style-type: none"> <li><b>1</b> Press the Menu / OK key.</li> <li><b>2</b> Select <b>"REMOVE HS"</b> and confirm.</li> <li><b>3</b> Enter the PIN code of the base station (default 0000).</li> <li><b>4</b> Enter the internal number of the handset you want to de-register (1-5) and confirm.</li> </ol> <p>Once the handset has been successfully de-registered, it reverts to standby mode. Otherwise you will be asked to enter the handset number again.</p> |
|----------------------------------------------------------------------------------------------------------------------------------------------------------------------------------------------------------------------------------------------------------------------------------------------------------------------------------------------------------------------------------------------------------------------------------------------------------------------------------------------------------------------------------------|-------------------------------------------------------------------------------------------------------------------------------------------------------------------------------------------------------------------------------------------------------------------------------------------------------------------------------------------------------------------------------------------------------------------------------------------------------------------------------------|

## 6.3 De-registering a handset from the Cocoon 8410 base station via the handset

- |                                                 |   |                                                                                     |
|-------------------------------------------------|---|-------------------------------------------------------------------------------------|
| → OK                                            | 1 | Press the Menu / OK key.                                                            |
| ▲▼ OK                                           | 2 | Select " <b>DE-REGISTER</b> " and confirm.                                          |
| 4 <sup>4</sup> 5 <sup>5</sup> 6 <sup>6</sup> OK | 3 | Enter the PIN code of the base station (default 0000).                              |
| 4 <sup>4</sup> 5 <sup>5</sup> 6 <sup>6</sup> OK | 4 | Enter the internal number of the handset you want to de-register (1-5) and confirm. |

Once the handset has been successfully de-registered, it reverts to standby mode. Otherwise you will be asked to enter the handset number again.



**Important** Handsets can only be de-registered when they are not in use.

## 6.4 Selecting a base station

If your handset is registered to more than one base station (max. 4), you must select one of these base stations since the handset only communicates with one base station at a time. There are two options:

### Auto Select

If you set the handset to 'Auto Select', the handset will automatically search for the nearest base station in standby mode.

- |       |   |                                            |
|-------|---|--------------------------------------------|
| → OK  | 1 | Press the Menu / OK key.                   |
| ▲▼ OK | 2 | Select " <b>HANDSET</b> " and confirm.     |
| ▲▼ OK | 3 | Select " <b>SELECT BASE</b> " and confirm. |
| ▲▼ OK | 4 | Select " <b>AUTOMATIC</b> " and confirm.   |







### Info

If you allow the base station to be selected automatically and the handset goes out of range of the current base station, the handset will only search for the strongest base station in standby mode (not during a call).

## Manual Select

If you set the handset to 'Manual Select', the handset will only search for the base station you have set.



- |                                                                                      |                                                     |
|--------------------------------------------------------------------------------------|-----------------------------------------------------|
|  OK | <b>1</b> Press the Menu / OK key.                   |
|  OK | <b>2</b> Select " <b>HANDSET</b> " and confirm.     |
|  OK | <b>3</b> Select " <b>SELECT BASE</b> " and confirm. |
|  OK | <b>4</b> Select " <b>MANUAL</b> " and confirm.      |
|  OK | <b>5</b> Select the base station and confirm.       |



**Important** For the base and the handset to be able to communicate, the handset must be registered to that base.

## 7 Call forwarding and internal calls from one handset to another

### 7.1 Call forwarding and conference calls during an external call

- |                                                                                                              |                                                                                                                                                                                                                                                                                                                                             |
|--------------------------------------------------------------------------------------------------------------|---------------------------------------------------------------------------------------------------------------------------------------------------------------------------------------------------------------------------------------------------------------------------------------------------------------------------------------------|
| <p><b>INT</b></p> <p></p> | <p><b>1</b> During an external call, press the <b>INT</b> key and then the number of the handset (1-5, select "0" for the base station).</p> <p>The other handset will ring.</p> <p>If the call was set up with the other handset, you can talk internally. When you hang up, the external call will be forwarded to the other handset.</p> |
| <p><b>INT</b></p>                                                                                            | <p><b>2</b> Hold down the <b>INT</b> key for 3 seconds. You can now talk to the second handset and the external call at the same time (conference call).</p>                                                                                                                                                                                |
| <p><b>INT</b></p> <p></p> | <p><b>3</b> Press the <b>INT</b> key again to switch back to the external call.</p> <p><b>4</b> Press the hang up key to end the call.</p>                                                                                                                                                                                                  |

## 7.2 Internal call (house phone function)



### Info

You can conduct a call between the base station and the cordless handset.

The base station has the internal number "0".

### INT

4<sup>3</sup> 5<sup>4</sup> 6<sup>5</sup>



- 1 In standby mode, press the **INT** key and then the number of the handset (1-5, select "0" for the base station).

The handset or base station you have called will now ring.

- 2 Press the call key or pick up the receiver on the base station.

You can now talk internally.

## 8 Abbreviations and technical terms

### CLIP

Calling Line Identification Presentation, display of the caller's telephone number on the called party's display.

### DECT

Digital Enhanced Cordless Telecommunication; European telecommunications standard for digital cordless telephones.

### ECO mode

Economic Mode; in DECT telephony this is low-radiation operation.

### Flash key

Effects a brief line interruption that is used to activate features such as toggling or call forwarding. On PBXs, the flash or **R** key is used for internal recall.

### GAP

Generic Access Profile; interface between the base station and handset that facilitates the cordless connection.

### INT

Internal subscriber. Other handset or extensions within a PBX

### Pulse mode

Obsolete analogue dialling mode ("clattering" dialling noises).

### LCD

Liquid Crystal Display

**LED**

Light Emitting Diode

**DTMF**

Dual Tone Multiple Frequency; modern, digital dialling mode.

**PIN**

Personal Identification Number.

**R key**

Recall key (see Flash key).

**Stand by**

"Idle" status of a device without being completely switched off.

**Twin**

Designation for a device unit with two identical devices e.g. two handsets.

## 9 Troubleshooting

<b>Problem</b>	<b>Possible cause</b>	<b>Solution</b>
No display	The batteries are not charged	Check that both batteries have been inserted correctly
		Charge the batteries
No sound	The telephone cable is not connected correctly.	Check the cable connection.
	The line is engaged by a different handset	Wait until the other handset hangs up
The caller is too quiet.		Adjust the volume during the call using the volume key
The handset ring tone is too quiet.		Adjust the ring tone volume
A number cannot be dialled.	The dialling mode is incorrectly set.	See „4.13 Setting the dialling mode“ to set the correct dialling mode

<b>Problem</b>	<b>Possible cause</b>	<b>Solution</b>
The  symbol is flashing	Handset is out of range	Move the handset within range of the base station.
	The base station has no power	Check the mains adapter and cable.
	The handset is not registered to the base station	Register the handset to the base
The base station or handset does not ring	The ring tone volume is off or too low	Adjust the ring tone volume
A call cannot be forwarded to an extension.	The flash time is too short	Set the device to a long flash time
The telephone does not respond when keys are pressed	Operating error	Remove the batteries and reinsert them.
<b>"LINE IN USE"</b>	The line is engaged by a different handset	Wait until the other handset hangs up

Do not modify or repair the device. The device or cable should only be repaired by a specialist in the service centre. Repairs that are not carried out properly can cause significant risks to the user.

## 10 Servicing

### 10.1 Maintenance

The device is maintenance-free. Occasionally check the condition of the batteries and replace them with new batteries of the same type if performance is impaired or if they are beginning to leak.



#### **Warning Danger of chemical burns!**

Wear protective gloves to remove flat rechargeable batteries.

if the device comes into contact with liquid, remove the batteries immediately and disconnect the device from the power supply (base

station) and dry it out carefully. Check its operation after 2-3 days. Send it into the service centre if it is defective.

## 10.2 Cleaning



### Warning

Risk of electric shock or short circuit from contact with components that conduct electricity.

Prevent liquids penetrating the device. If this should occur, unplug the mains adapter from the power socket and the telephone cable connector from the wall socket and remove the batteries.

Do the same if the device, cable or mains adapter are damaged: avoid direct contact with liquids and disconnect the device from the 230 V mains immediately.

Clean the telephone with a damp cloth that has been dipped in lukewarm water or an anti-static cloth. Never use cleaning agents or abrasives.

## 10.3 Decommissioning, storage

To decommission the device temporarily, disconnect the telephone cable from the wall socket and from the telephone jack on the base station. Unplug the base station and handset mains adapters from the 230 V sockets.

Remove the batteries from the handsets. If the telephone is decommissioned for a long time, replace the rechargeable batteries with new ones of the same type when the phone is recommissioned. Store the devices and rechargeable batteries in a dry place that is not too warm.

## 10.4 Disposal (environmental protection)



The device and rechargeable batteries must not be disposed of in normal household refuse at the end of their service life. This is indicated by this symbol on the product and/or on the packaging. Take the device to a collection point for recycling electrical and electronic devices. Some of the materials in the product can be recycled there. You can help the environment by recycling some parts or raw

materials from used products.

Also dispose of packaging materials in an environmentally friendly way.

Contact your local authority for more information on collection points in your area.

## 11 Technical data

Standard	<b>DECT (Digital Enhanced Cordless Telecommunications)</b> <b>GAP (Generic Access Profile)</b>
Frequency range	1,880 MHz to 1,900 MHz
Emissions	10 mW (average output per channel)
Range	Up to 300 m in open terrain - up to 50 m in buildings
Handset batteries:	2 x 1.2 V, 450mAh AAA type rechargeable NiMh batteries
Base station power supply	Input: 100~240 V AC / 50-60 Hz Output: 6 V DC/ 500 mA
Charger power supply:	Input: 100~240 V AC / 50-60 Hz Output: 7 V DC/ 420 mA
Handset standby time:	100 hours in standby mode
Handset talk time	10 hours
Charging time:	16 hours
Permitted operating temperatures	+5 °C to + 45 °C
Permitted relative humidity	25 to 85 %
Dialling mode	Pulse and tone dialling (DTMF)
Flash time	100 or 300 ms
Handset number memory	50 phone book entries of up to 24 digits and 16 letters
Base station number memory	3 direct abbreviated dial numbers (M1-M3) of up to 24 digits 50 phone book entries of up to 24 digits and 16 letters
Dimensions Base station / Charger / Handset	200 mm x 80 mm x 182 mm / 100 mm x 103 mm x 60 mm / 182 mm x 28 mm x 55 mm

Weight Base station / Charger / Handset	763 g with mains adapter / 145 g with mains adapter / 151 g with batteries
Maximum power consumption	Base station with receiver: 2.0 W Charger with handset: 1.3 W

## 12 Warranty

### 12.1 Warranty period

Ucom devices have a warranty period of 36 months. The warranty period begins on the day on which the new device was purchased. The warranty does not cover ordinary batteries (AA and AAA).

Consumables and damages which have insignificant effects on the operation or value of the device are not covered.

Warranty claims must be accompanied by the original receipt or a copy thereof, showing the purchase date and device model.

### 12.2 Warranty claim handling

Send the defective device to an authorised service centre together with a valid receipt and completed service card.

If the device develops a fault during the warranty period, the service centre will resolve any defect caused by a material or manufacturing fault by repairing or replacing the device or the relevant parts. In the event of a replacement, the colour and the model may deviate from those of the originally purchased device.

The original purchase date determines the beginning of the warranty period. The warranty period is not extended when the device is exchanged or repaired by the responsible service centre.

### 12.3 Warranty exclusions

Damage or defects caused by incorrect use or operation, and defects caused by the use of non-original parts or accessories, are not covered by the warranty.

The warranty does not cover damage caused by external influences such as lightning strike, water and fire, or transport damage.

The warranty shall be invalidated if the serial number of the device is changed, removed or rendered illegible.

All warranty claims shall become null and void if the purchaser has repaired, modified or converted the device.

This device may only be operated with rechargeable batteries. If you want to replace the original rechargeable batteries supplied, please check that the new batteries are suitable and rechargeable. Under NO circumstances may alkaline batteries be used in the handsets.

If you use alkaline batteries and place the handset in the charger, the batteries will heat up and may explode. Any defects caused by this will not be compensated by the manufacturer and any device damaged in this way will not be covered by the warranty. All repairs will be billed to you.

### **13 Customer service address and support**

See separate document (customer service address and support telephone numbers) or [www.ucom.be](http://www.ucom.be)

### **14 Conformity and manufacturer**

Topcom Europe Nv.  
Grauwmeer 17  
3001 Heverlee  
Belgium

## 15 Index

<b>A</b>		<b>K</b>	
Abbreviations	38	Key lock	30
<b>B</b>		<b>L</b>	
Base station	17	Loudspeaker	20
<b>C</b>		<b>M</b>	
Call forwarding	37	Making a call	19,27
Call list	24	Menu	16
Call preparation	27	Mute	20, 28
Caller ID	32	<b>O</b>	
Conference calling	37	Outgoing calls	19, 27
Contents of box	6	<b>P</b>	
Cordless handset	26	Paging	26
<b>D</b>		Phone book	20, 31
Date	18	PIN code	23
Default settings	23, 34	Pulse dialling mode	22
Dialling mode	22	<b>R</b>	
Display	15	R key	26, 29
Display language	17	Registering handset	34
<b>E</b>		Rechargeable batteries	12
ECO mode	10	Ring tone	22
<b>F</b>		Ring tone volume	22
Finding the handset	26	<b>S</b>	
Flash	26, 29	Safety notes	7
<b>G</b>		Signal words	6
General information	5	Symbols	6
<b>H</b>		<b>T</b>	
Hands free mode	20, 28	Time	18
Handset name	30	Time format	18
Handset ring tone volume	29	Tone dialling mode	22
<b>I</b>		<b>U</b>	
Intended use	6	Using the cordless handset	26
		Using the keys	17



# DECLARATION OF CONFORMITY

We manufacturer, Topcom Europe Nv, Grauwmeer 17 , 3001 Heverlee , Belgium, declare that our product :

**Type: Wireless Telephone Device (DECT)**

**Model: Cocoon 8410**

**Class of equipment: Class 1**

is in compliance with the essential requirements and other relevant provisions of the: R&TTE directive 1999/5/EC

EuP-Directive 2009/125/EC

and carries the CE mark accordingly.

Supplementary information:

The product complies with the requirements of:

Directive 1999/5/EC (R&TTE)

Safety:

EN 60950-1/A11:2009

EMC:

ETSI EN 301 489-1 V1.8.1

ETSI EN 301 489-6 V1.3.1

Efficient use of frequency spectrum:

ETSI EN 301 406 V1.5.1

Health:

EN 50360:2001-07

EN 50385:2002-08

Directive 2009/125/EC (EuP)

Regulation 278/2009

Date: 16/11/2010

Place: Heverlee , Belgium

Name: Verheyden Geert

Function: Technical Director

Signature:



European contact: Topcom Europe Nv, R&D department, Research Park, Grauwmeer 17, 3001 Heverlee, Belgium. Tel : +32 16 398920 , Fax : +32 16 398939

***SILVER CREST***<sup>®</sup>

**COCOON 8410**

visit our website  
**[www.ucom.be](http://www.ucom.be)**